

JVC



COMPACT VHS CAMCORDER

GR-AX957UM
GR-AX857UM
GR-AX657UM

ENGLISH

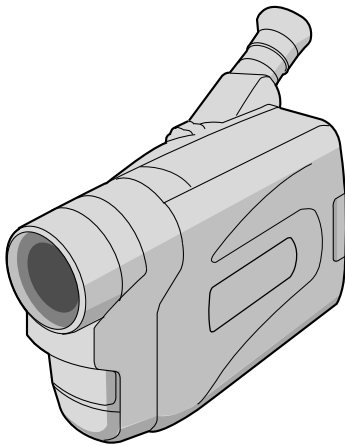

Compact VHS



INSTRUCTIONS



LYT0305-001A

EN

Dear Customer,

Thank you for purchasing the JVC Compact VHS camcorder. Before use, please read the safety information and precautions contained in the following pages to ensure safe use of your new camcorder.

Using This Instruction Manual

- All major sections and subsections are listed in the Table Of Contents (☞ pg. 7).
- Notes appear after most subsections. Be sure to read these as well.
- Basic and advanced features/operation are separated for easier reference.

It is recommended that you . . .

- refer to the Index (☞ pgs. 52 – 55) and familiarize yourself with button locations, etc. before use.
- read thoroughly the Safety Precautions and Safety Instructions that follow. They contain extremely important information regarding the safe use of this product.

You are recommended to carefully read the cautions on pages 56 and 57 before use.

SAFETY PRECAUTIONS

WARNING:
TO PREVENT FIRE OR SHOCK HAZARD, DO NOT EXPOSE THIS UNIT TO RAIN OR MOISTURE.

CAUTIONS:

- To prevent shock, do not open the cabinet. No user serviceable parts inside. Refer servicing to qualified personnel.
- When you are not using the AC Power Adapter/Battery charger for a long period of time, it is recommended that you disconnect the power cord from AC outlet.

Warning on lithium battery (for clock operation)

The battery used in this device may present a fire or chemical burn hazard if mistreated. Do not recharge, disassemble, heat above 100°C or incinerate.

Replace battery with Maxell, Panasonic (Matsushita Electric), Sanyo or Sony CR2025; use of another battery may present a risk of fire or explosion.

- Dispose of used battery promptly.
- Keep away from children.
- Do not disassemble and do not dispose of in fire.

This camcorder is designed to be used with NTSC-type color television signals. It cannot be used for playback with a television of a different standard. However, live recording and viewfinder playback are possible anywhere. Use the BN-V11U/V12U/V20U battery packs and, to recharge them, the provided multi-voltage AC Power Adapter/Charger. (An appropriate conversion adapter may be necessary to accommodate different designs of AC outlets in different countries.)

NOTES:

- *The rating plate (serial number plate) and safety caution are on the bottom and/or the back of the main unit.*
- *The rating plate (serial number plate) of the AC Power Adapter/Charger is on its bottom.*

This unit is produced to comply with Standard IEC Publ. 65.

IMPORTANT PRODUCT SAFETY INSTRUCTIONS

Electrical energy can perform many useful functions. But improper use can result in potential electrical shock or fire hazards. This product has been engineered and manufactured to assure your personal safety. In order not to defeat the built-in safeguards, observe the following basic rules for its installation, use and servicing.

ATTENTION:

Follow and obey all warnings and instructions marked on your product and its operating instructions. For your safety, please read all the safety and operating instructions before you operate this product and keep this manual for future reference.

INSTALLATION

1. Power Sources

Operate your product only from the type of power source indicated on the marking label. If you are not sure of the type of power supply to your home, consult your product dealer or local power company. If your product is intended to operate from battery power, or other sources, refer to the operating instructions.

2. Overloading

Do not overload wall outlets, extension cords, or integral convenience receptacles as this can result in a risk of fire or electric shock.

3. Power Cord Protection

Power supply cords should be routed so that they are not likely to be walked on or pinched by items placed upon or against them, paying particular attention to cords at plugs, convenience receptacles, and the point where they exit from the product.

4. Ventilation

Slots and openings in the cabinet are provided for ventilation. To ensure reliable operation of the product and to protect it from overheating, these openings must not be blocked or covered.

- Do not block the openings by placing the product on a bed, sofa, rug or other similar surface.
- Do not place the product in a built-in installation such as a bookcase or rack unless proper ventilation is provided or the manufacturer's instructions have been adhered to.

5. Wall or Ceiling Mounting

The product should be mounted to a wall or ceiling only as recommended by the manufacturer.

ANTENNA INSTALLATION INSTRUCTIONS

1. Outdoor Antenna Grounding

If an outside antenna or cable system is connected to the product, be sure the antenna or cable system is grounded so as to provide some protection against voltage surges and built-up static charges. Article 810 of the National Electrical Code, ANSI/NFPA 70, provides information with regard to proper grounding of the mast and supporting structure, grounding of the lead-in wire to an antenna discharge unit, size of grounding conductors, location of antenna discharge unit, connection to grounding electrodes, and requirements for the grounding electrode.

2. Lightning

For added protection for this product during a lightning storm, or when it is left unattended and unused for long periods of time, unplug it from the wall outlet and disconnect the antenna or cable system. This will prevent damage to the product due to lightning and power-line surges.

3. Power Lines

An outside antenna system should not be located in the vicinity of overhead power lines or other electric light or power circuits, or where it can fall into such power lines or circuits. When installing an outside antenna system, extreme care should be taken to keep from touching such power lines or circuits as contact with them might be fatal.

EXAMPLE OF ANTENNA GROUNDING AS PER NATIONAL ELECTRICAL CODE, ANSI/NFPA 70

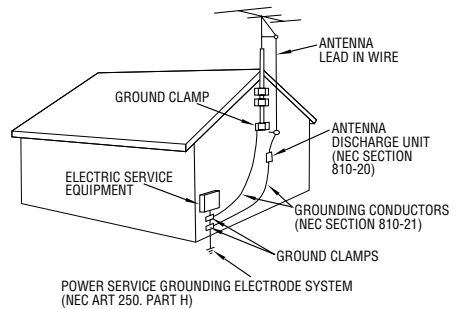

NEC – NATIONAL ELECTRICAL CODE

USE

1. Accessories

To avoid personal injury:

- Do not place this product on an unstable cart, stand, tripod, bracket or table. It may fall, causing serious injury to a child or adult, and serious damage to the product.
- Use only with a cart, stand, tripod, bracket, or table recommended by the manufacturer or sold with the product.
- Use a mounting accessory recommended by the manufacturer and follow the manufacturer's instructions for any mounting of the product.
- Do not try to roll a cart with small casters across thresholds or deep-pile carpets.

2. Product and Cart Combination

A product and cart combination should be moved with care. Quick stops, excessive force, and uneven surfaces may cause the product and cart combination to overturn.

PORTABLE CART WARNING
(Symbol provided by RETAC)



3. Water and Moisture

Do not use this product near water—for example, near a bath tub, wash bowl, kitchen sink or laundry tub, in a wet basement, or near a swimming pool and the like.

4. Object and Liquid Entry

Never push objects of any kind into this product through openings as they may touch dangerous voltage points or short-out parts that could result in a fire or electric shock. Never spill liquid of any kind on the product.

5. Attachments

Do not use attachments not recommended by the manufacturer of this product as they may cause hazards.

6. Cleaning

Unplug this product from the wall outlet before cleaning. Do not use liquid cleaners or aerosol cleaners. Use a damp cloth for cleaning.

7. Heat

The product should be situated away from heat sources such as radiators, heat registers, stoves, or other products (including amplifiers) that produce heat.

SERVICING

1. Servicing

If your product is not operating correctly or exhibits a marked change in performance and you are unable to restore normal operation by following the detailed procedure in its operating instructions, do not attempt to service it yourself as opening or removing covers may expose you to dangerous voltage or other hazards. Refer all servicing to qualified service personnel.

2. Damage Requiring Service

Unplug this product from the wall outlet and refer servicing to qualified service personnel under the following conditions:

- When the power supply cord or plug is damaged.
- If liquid has been spilled, or objects have fallen into the product.
- If the product has been exposed to rain or water.
- If the product does not operate normally by following the operating instructions. Adjust only those controls that are covered by the operating instructions as an improper adjustment of other controls may result in damage and will often require extensive work by a qualified technician to restore the product to its normal operation.
- If the product has been dropped or damaged in any way.
- When the product exhibits a distinct change in performance—this indicates a need for service.

3. Replacement Parts

When replacement parts are required, be sure the service technician has used replacement parts specified by the manufacturer or have the same characteristics as the original part. Unauthorized substitutions may result in fire, electric shock or other hazards.

4. Safety Check

Upon completion of any service or repairs to this product, ask the service technician to perform safety checks to determine that the product is in safe operating condition.

SUPPLY POWER

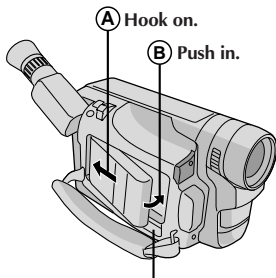

BATTERY RELEASE

Using the battery pack

Hook its end to the camcorder (A) and push the battery pack in until it locks in place (B).
(Charging procedure, pg. 8)

To remove the battery pack

Slide **BATTERY RELEASE** and pull out the battery pack.

INSERTING A VIDEO CASSETTE

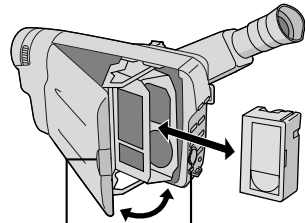

PUSH Button EJECT Switch

- 1 Slide **EJECT** to open the cassette holder.
- 2 Insert a video cassette.
- 3 Press **PUSH** to close the cassette holder.
(For more details, pg. 13)

PLAYBACK

2 REW (◀◀) Button

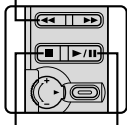

3 PLAY/PAUSE (▶/||) Button

STOP (■) Button

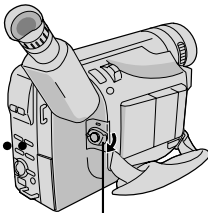

1 Set to "PLAY"

- 1 Set the Power Switch to "PLAY".
 - 2 Press **REW** (◀◀).
— The tape will automatically stop at the beginning of the tape.
 - 3 Press **PLAY/PAUSE** (▶/||).
— Playback starts and the playback picture appears.
- To stop playback, press **STOP** (■).
(For more details, pg. 39.)

Or simply play back the tape on a VHS VCR using the Cassette Adapter (VHS Playpak).
 pg. 41

SHOOTING

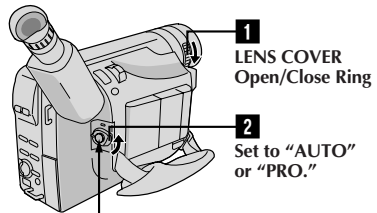

1 **LENS COVER**
Open/Close Ring

2 Set to "AUTO"
or "PRO."

3 **Recording Start/Stop Button**

- 1 Turn the **LENS COVER** Open/Close Ring to open the lens cover.
 - 2 Set the Power Switch to "AUTO" or "PRO.". — The power lamp will light and an image will appear.
 - 3 Press the Recording Start/Stop Button.
— Recording starts.
- To stop recording temporarily, momentarily press the Recording Start/Stop Button once again.
(For more details, pgs. 16, 17)

REMEMBER

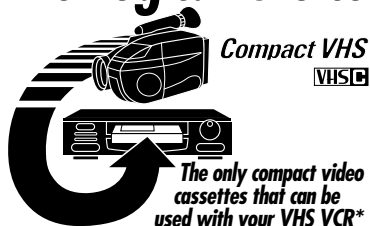
The Logical Choice

*The only compact video cassettes that can be used with your VHS VCR**

*with VHS Playpak

Program AE with Special Effects (☞ pg. 24, 25)

- Electronic Fog Filter
- ND Effect
- Sepia
- Twilight
- Sports
- Nega/Posi
- 1/2000 sec. High Speed Shutter

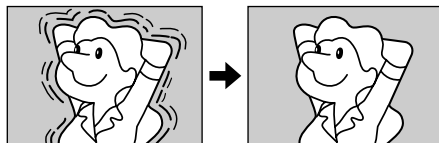
Snapshot (GR-AX957 only) (☞ pg. 22)**5-Sec. Recording (GR-AX857/AX657 only)** (☞ pg. 19)**Menu Adjustment** (☞ pg. 28, 29, 30)**Integrated Auto Light (GR-AX957/AX857 only)** (☞ pg. 21)**Picture Stabilizer** (☞ pg. 20)**Digital Hyper Zoom** (☞ pg. 18)

Zoom in



Zoom out

PROVIDED ACCESSORIES

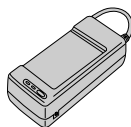

- AC Power Adapter/Charger AA-V15U

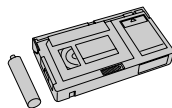

- Cassette Adapter (VHS Playpak) C-P7U



- Battery Pack
 - GR-AX957: BN-V20U
 - GR-AX857/AX657: BN-V11U

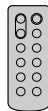

- Remote Control Unit RM-V705U (GR-AX957/AX857 only)



- Lithium Battery CR2025 x 1 (for clock operation)

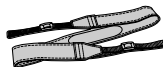

- Shoulder Strap

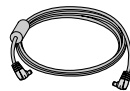

- DC Cord

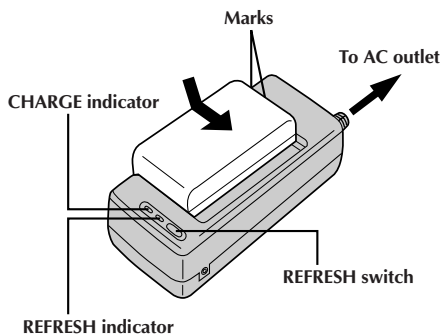

GETTING STARTED	8 – 15
Power	8
Clock (Lithium) Battery Insertion/Removal	10
Date/Time Settings	11
Recording Mode Setting	12
Tape Length Setting	12
Loading/Unloading A Cassette	13
Grip Adjustment	14
Viewfinder Adjustment	14
Shoulder Strap Attachment	15
Tripod Mounting	15
RECORDING	16 – 37
Basic Recording	16
Basic Features	18
Advanced Features	22
PLAYBACK	38 – 43
Basic Playback	38
Features	39
Using The Cassette Adapter	41
Basic Connections And Tape Dubbing	42
USING THE REMOTE CONTROL UNIT	44 – 47
Insert Editing	46
Audio Dubbing	47
USER MAINTENANCE	48
TROUBLESHOOTING	49 – 50
INDEX	51 – 54
Indications	51
Controls, Connectors And Indicators	52
Terms	54
CAUTIONS	55 – 56
SPECIFICATIONS	57
OPTIONAL ACCESSORIES	57

**REFRESH**

The AC Power Adapter/Charger features a REFRESH function that allows you to fully discharge the battery pack before recharging. Perform the REFRESH function after no less than 5 chargings.

To discharge the battery . . .

.... attach the battery pack to the adapter as shown in the above illustration. Then push REFRESH. The REFRESH indicator lights when discharging starts, and goes out when discharging is complete.

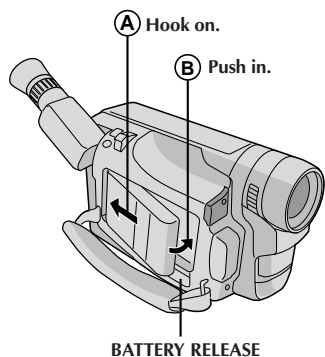
**ATTENTION:**

Before detaching the power source, make sure that the camcorder's power is turned off. Failure to do so can result in a camcorder malfunction.

Power

This camcorder's 3-way power supply system lets you choose the most appropriate source of power.

NOTES:

- No function is available without power supply.
- Use only the specified power supply.
- Do not use provided power supply units with other equipment.

CHARGING THE BATTERY PACK**1 SUPPLY POWER**

Connect the charger's AC power cord to a wall outlet.

2 ATTACH BATTERY PACK

Align the marks and slide the battery pack in the direction of the arrow until it locks in place.

- The CHARGE indicator begins blinking to indicate charging has started.

3 DETACH BATTERY PACK

When the CHARGE indicator stops blinking but stays lit, charging is finished. Slide the battery pack opposite the direction of the arrow.

Battery pack	Charging time	Discharging time
BN-V11U	approx. 1 hr. 10 min.	approx. 3 hrs. 30 min.
BN-V12U	approx. 1 hr. 10 min.	approx. 3 hrs. 30 min.
BN-V20U	approx. 1 hr. 50 min	approx. 6 hrs. 40 min.

USING THE BATTERY PACK**1 ATTACH BATTERY PACK**

Hook its end to the camcorder (A) and push the battery pack in until it locks in place (B).

2 DETACH BATTERY PACK

Slide BATTERY RELEASE and pull out the battery pack.

Approximate recording time (unit: min.)

Battery pack	GR-AX957	GR-AX857	GR-AX657
BN-V11U	70 (40)	70 (40)	70
BN-V12U	70 (40)	70 (40)	70
BN-V20U	110 (65)	110 (65)	110

() : when the video light is on.
(AX957/AX857 only)

INFORMATION:

VU-V856KIT is a set composed of the BN-V856U battery pack and AA-V80U AC Power Adapter/Charger. The BN-V856U battery pack provides approx. 7 hours of recording time when the video light is off. Also read thoroughly the VU-V856KIT's instruction manuals. It is impossible to charge the BN-V856U battery pack using the provided AC Power Adapter/Charger. Use the optional AA-V80U AC Power Adapter/Charger.

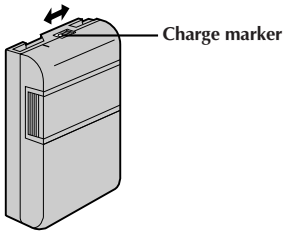

Charge Marker

A charge marker is provided on the battery pack to help you remember whether it has been charged or not. Two colors are provided (red and black)—you choose which one means charged and which means discharged.

NOTES:

- The recording time per charge is affected by such factors as the time spent in Record-Standby mode and the frequency of zooming. It is safer to have spare battery packs to cover 3 times the planned shooting time.
- Charging times noted on page 8 are for a fully discharged battery pack, and discharging times are for a fully charged battery pack.
- Charging and discharging times vary according to the ambient temperature and the status of the battery pack.
- Remember to set the charge marker after charging a battery pack or after detaching a discharged one from your camcorder.
- Perform the REFRESH function after no less than 5 chargings.
- While the AC Power Adapter/Charger's power cord is disconnected from the AC outlet, it is possible to discharge the battery by pressing the REFRESH switch. During that time, the AC Power Adapter/Charger does not charge the battery. When discharging is complete, detach the battery from the AC Power Adapter/Charger to store it.
- High temperatures can damage the battery pack, so use only where good ventilation is available. Do not allow it to discharge in a container, such as a bag.
- If you stop recharging or discharging part way through, make sure to remove the battery pack before unplugging the adapter's AC cord.
- Remove the battery pack from the adapter immediately after discharging.
- To avoid interference with reception, do not use the AC Power Adapter/Charger near a radio.
- Make sure you unplug the DC cord before charging or discharging the battery pack.
- The CHARGE indicator may not light properly with a brand new battery pack, or with one that has been stored for an extended period. In this case, remove and reattach the battery pack and recharge it. The CHARGE indicator should blink during recharging. If it doesn't, contact your nearest JVC dealer.

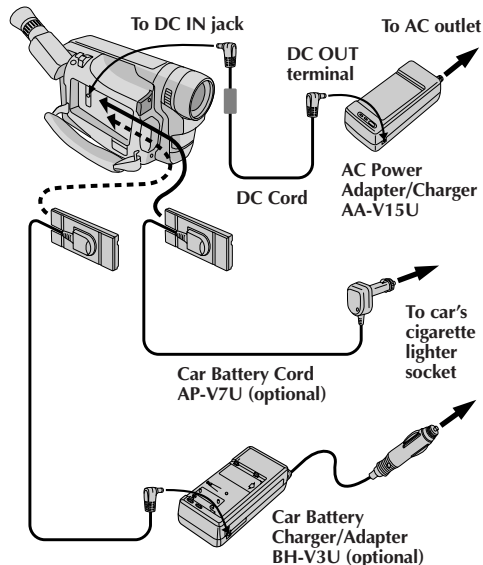

USING AC POWER

Use the AC Power Adapter/Charger (connect as shown in the illustration to the left).

NOTES:

- The provided AC Power Adapter/Charger features automatic voltage selection in the AC range from 110 V to 240 V.
- When using the DC cord, make sure you connect the end of the cord with the core filter to the camcorder. The core filter reduces interference.

USING A CAR BATTERY

Use the optional Car Battery Cord or Car Battery Charger/Adapter (connect as shown in the illustration to the left).

NOTES:

- When using the car battery, leave the engine idling.
- The optional Car Battery Charger/Adapter (BH-V3U) can also be used to charge the battery pack (except BN-V20U/V856U).
- When using the optional Car Battery Charger/Adapter or Car Battery Cord (AP-V7U), refer to the respective instruction booklet.

Clock (Lithium) Battery Insertion/Removal

This battery is necessary for clock operation and to perform date/time settings.

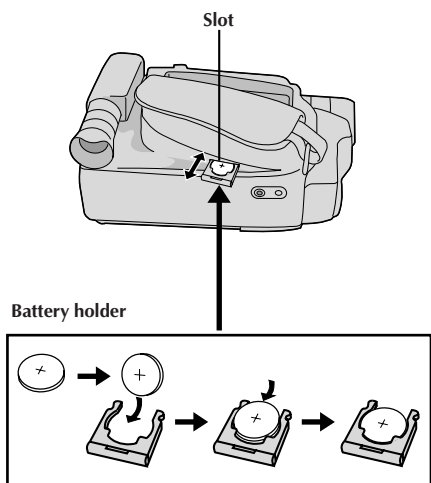

1 SWITCH OFF POWER

Switch off the unit's power and remove the power supply unit (battery pack, AC Power Adapter/Battery Charger, etc.).

2 REMOVE BATTERY HOLDER

Pull out the battery holder.

3 INSERT BATTERY IN HOLDER

Insert the battery in the holder, and be sure to have the "+" mark visible.

4 RE-INSERT HOLDER

Slide the holder back into the slot until you hear a click.

NOTE:

See "SAFETY PRECAUTIONS" (☞ pg. 2) for information on safe handling of lithium batteries.

Date/Time Settings

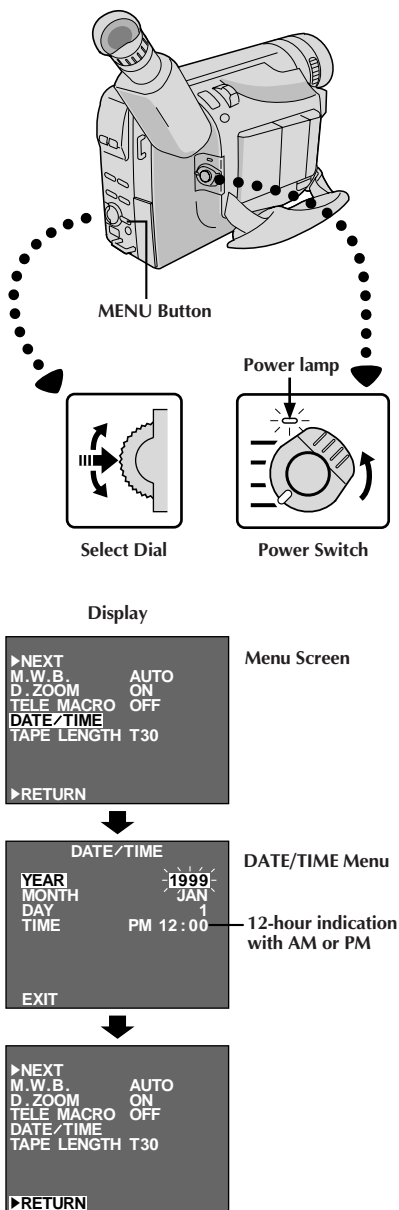

1 ACCESS MENU SCREEN

Set the Power Switch to "PRO.", then press MENU.

- The power lamp comes on.

2 SELECT FUNCTION

Rotate the Select Dial to move the highlight bar to "DATE/TIME", then press it. The DATE/TIME Menu appears.

- If you decide you want to return the date and time to the previous settings, rotate the Select Dial to move the highlight bar to "EXIT" and press it, then go to step 6.
- If you want to set only the time without changing the date, go to step 4.

3 SET DATE

Rotate the Select Dial to move the highlight bar to the item you want to set and then press it. When the setting begins blinking, rotate the Select Dial until the correct setting appears and then press it. The setting stops blinking.

- Repeat this procedure until you're satisfied with the Date settings ("YEAR", "MONTH" and "DAY").

4 SET TIME

Rotate the Select Dial to move the highlight bar to "TIME" and then press it. When the hour setting begins blinking, rotate the Select Dial until the correct setting appears and then press it. When the hour setting stops blinking and the minute setting begins blinking, rotate the Select Dial until the correct setting appears and then press it. The minute setting stops blinking.

5 START CLOCK OPERATION

When none of these settings ("YEAR", "MONTH", "DAY", "TIME") blinks, rotate the Select Dial to move the highlight bar to "EXIT", and press it. The Menu Screen reappears with the highlight bar on "RETURN".

6 CLOSE MENU SCREEN

Press the Select Dial.

NOTE:

To display the date and time in the camcorder's display and on a connected TV, see "Date/Time Insert" (pg. 26).

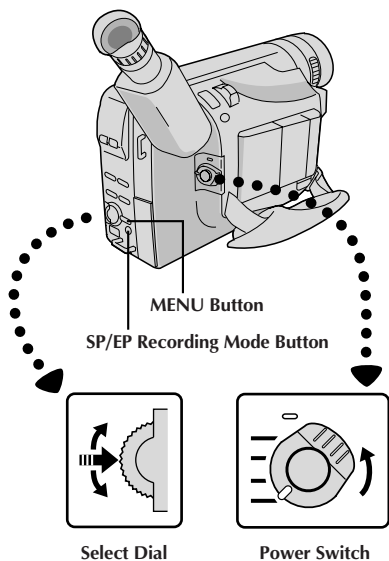

Viewfinder

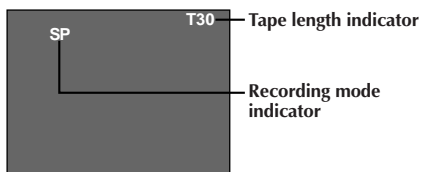

Display

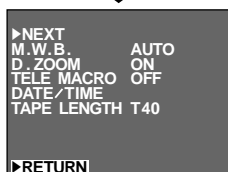
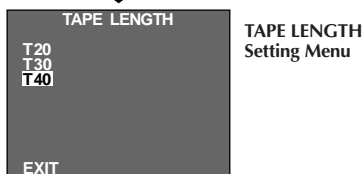
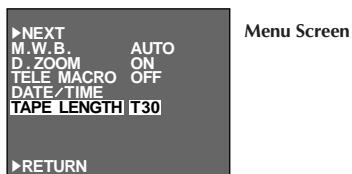

Recording Mode Setting

Set depending on your preference.

1 SET RECORDING MODE

First set the Power Switch to "AUTO" or "PRO.". Press **SP/EP** for more than 1 second. "SP" (Standard Play) provides higher picture and sound quality and is better for dubbing, while "EP" (Extended Play) is more economical, providing three times the recording time.

NOTE:

If the recording mode is switched during recording, the playback picture will be blurred at the switching point.

Tape Length Setting

Set the tape length according to the length of the tape used.

1 ACCESS MENU SCREEN

First set the Power Switch to "PRO.". Press **MENU**.

2 SELECT FUNCTION

Rotate the Select Dial to move the highlight bar to "TAPE LENGTH", then press it. The TAPE LENGTH Setting Menu appears.

3 SET TAPE LENGTH

Rotate the Select Dial to move the highlight bar to the correct setting. T20=20 minutes of recording time, T30=30 minutes, and T40=40 minutes (in SP).

- If you decide you want to return the tape length to the previous setting, rotate the Select Dial to move the highlight bar to "EXIT".

4 CLOSE MENU SCREEN

Press the Select Dial. The Menu Screen reappears with the highlight bar on "RETURN". Press the Select Dial again to close the Menu Screen.

NOTE:

The tape remaining time (⏪ pg. 17) displayed in the viewfinder is correct only if the correct tape length has been selected.

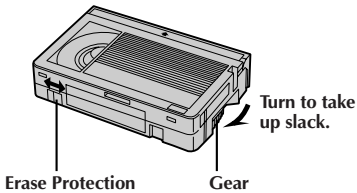
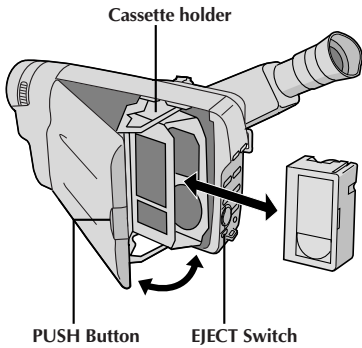

Loading/Unloading A Cassette

- 1 OPEN CASSETTE HOLDER**
Slide **EJECT** until the holder opens. Do not use force to open.
- 2 INSERT/REMOVE CASSETTE**
Make sure the label is facing outward.
- 3 CLOSE CASSETTE HOLDER**
Press **PUSH** and make sure the holder is closed and locked.

NOTES:

- The cassette holder can't be opened unless a power supply is attached.
- Make sure that the tape is not slack when loading the cassette. If there is any slack, turn the gear on the cassette in the direction of the arrow to take up the slack.
- Make sure the Erase Protection tab is in the position that allows recording. If not, slide the tab. Some cassettes have removable tabs. If the tab has been removed, cover the hole with adhesive tape.
- The cassette holder cannot be opened while the camcorder is in the record mode.

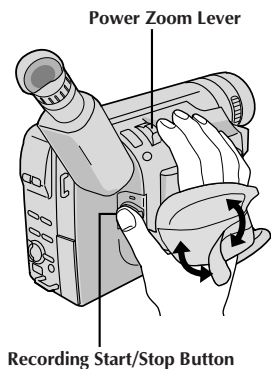

Grip Adjustment

- 1 EXPAND LOOP**
Separate the Velcro strip.
- 2 INSERT HAND**
Pass your right hand through the loop and grasp the grip.
- 3 ADJUST STRAP LENGTH**
Adjust so your thumb and fingers can easily operate the Recording Start/Stop Button and Power Zoom Lever. Refasten the Velcro strip.

Viewfinder Adjustment

- 1 SELECT OPERATION MODE**
Set the Power Switch to "CAMERA" ("AUTO" or "PRO.").
- 2 POSITION VIEWFINDER**
Adjust the viewfinder manually for best viewability (see illustration at left).
- 3 ADJUST DIOPTR**
Turn the Diopter Adjustment Control until the indications in the viewfinder are clearly focused.

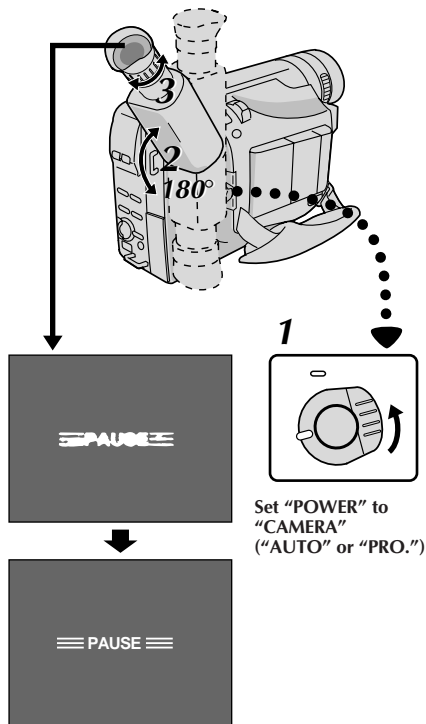

Shoulder Strap Attachment

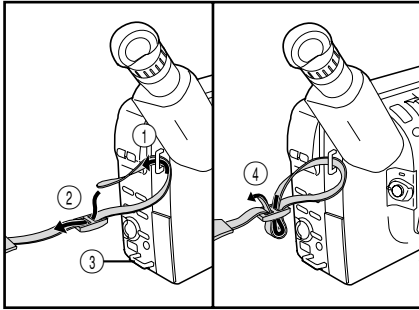

1 ATTACH STRAP

Following the illustration at left, thread the strap through the top of the eyelet (1), then fold it back and thread it through the buckle (2). Repeat the procedure to attach the other end of the strap to the other eyelet (3), making sure the strap is not twisted.

2 ADJUST LENGTH

Adjust as shown in the illustration at left (4).

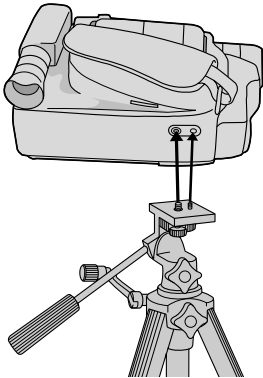

Tripod Mounting

1 ALIGN AND TIGHTEN

Align the screw and camera direction stud on the tripod with the camera's mounting socket and stud hole. Then tighten the screw.

CAUTION:

When using a tripod, be sure to open and extend its legs fully to stabilize the camcorder. To prevent damage to the unit caused by falling over, do not use a small-sized tripod.

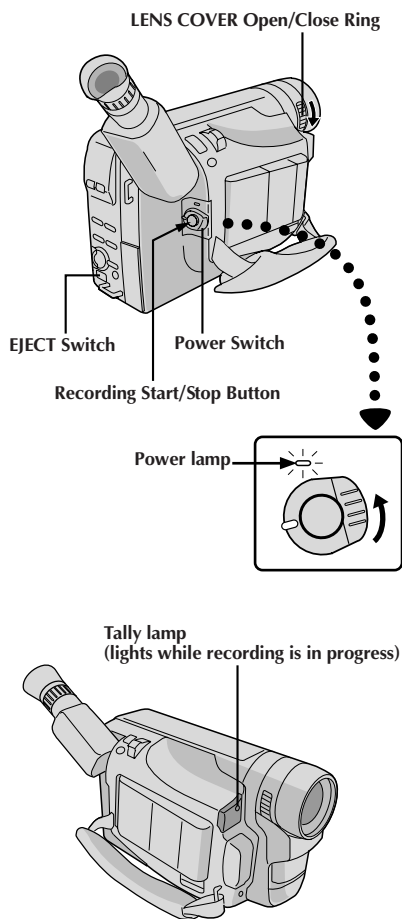
**NOTE:**

You should already have performed the procedures listed below. If not, do so before continuing.

- Power (☞ pg. 8)
- Recording Mode Setting (☞ pg. 12)
- Tape Length Setting (☞ pg. 12)
- Grip Adjustment (☞ pg. 14)
- Viewfinder Adjustment (☞ pg. 14)

1 LOAD A CASSETTE

Slide **EJECT** to open the cassette holder, then insert the cassette with the label facing out. Press **PUSH** to ensure the holder is closed and locked.

2 ENTER RECORD-STANDBY MODE

Turn the **LENS COVER** Open/Close Ring to open the lens cover, then set the Power Switch to "CAMERA" ("AUTO" or "PRO.").

- The power lamp lights and the camcorder enters the Record-Standby mode.
- The scene you are aimed at appears on the viewfinder screen, with the word "PAUSE" superimposed upon it.

3 START SHOOTING

Press the Recording Start/Stop Button.

- "REC" appears in the viewfinder while recording is in progress.

Power Switch Position

According to the Power Switch position you have selected, the following functions are available:

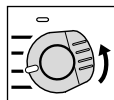

AUTO
(Full Auto mode):

Allows you to record using NO special effects or manual adjustments. Suitable for standard recording.

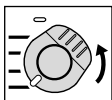

PRO.
(PRO. mode):

Allows you to set various recording functions using the menus. If you want more creative capabilities than full auto recording, try this mode.

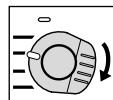

POWER OFF:

Allows you to switch off the camcorder.

Tape remaining time indicator

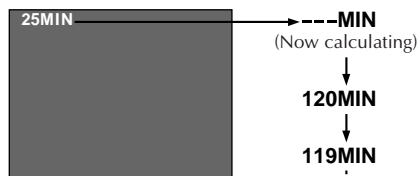

120MIN

119MIN

3MIN

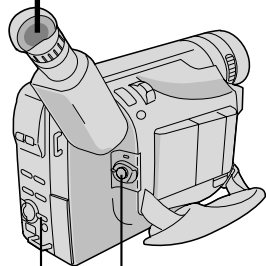
2MIN
(Blinking)1MIN
(Blinking)0MIN
(Blinking)

Recording Start/Stop Button

DISPLAY Button

4 STOP RECORDING

Press the Recording Start/Stop Button again to stop recording.

- The camcorder re-enters the Record-Standby mode.

NOTES:

- The cassette holder cannot be opened unless a power supply is attached.
- There may be a delay after you slide **EJECT** until the holder opens. Do not use force.
- The tape remaining time is displayed in the viewfinder as shown.
- The remaining time indicated in the viewfinder is approximate.
- The time required to calculate the remaining tape length, and the accuracy of the calculation, may vary according to the type of tape used.
- The tape remaining time indicator is correct only if the correct tape length has been selected (☞ pg. 12).
- "TAPE END" appears when the tape reaches its end, and the power goes off automatically if left in this condition for 5 minutes. "TAPE END" also appears when a cassette whose tape is already at its end is loaded.
- If the Record-Standby mode continues for 5 minutes without performing Zoom or any other operations, the camcorder's power shuts off automatically. Set the Power Switch to "POWER OFF", and then back to "CAMERA" to turn the camcorder on again.
- If the Recording Start/Stop button is pressed after the Record-Standby mode has continued for over 5 minutes, recording may not start immediately.
- If you are recording on a cassette from the middle (such as when a tape is removed and re-inserted during recording), use the Retake function (☞ pg. 19) to find the end of the last recording so you don't erase any of it.
- The LENS COVER warning blinks for about 5 seconds when the camcorder is turned on with the cover closed.
- To turn the tally lamp off during recording, refer to pgs. 30 and 32.

RECORDING

Viewfinder Indications

Press **DISPLAY** to make the following indications appear/disappear from the camcorder's display: cassette warning, tape remaining time, battery pack remaining power indicator and tape length indicator (☞ pg. 52).

1 PRESS DISPLAY BUTTON

To turn off the indications, press **DISPLAY** for more than 1 second.

Press again for more than 1 second to make the indications reappear.

NOTE:

Even if the indications are off, the tape remaining time appears blinking when the tape is near its end, and the battery pack remaining power indicator appears blinking when the power is almost gone.

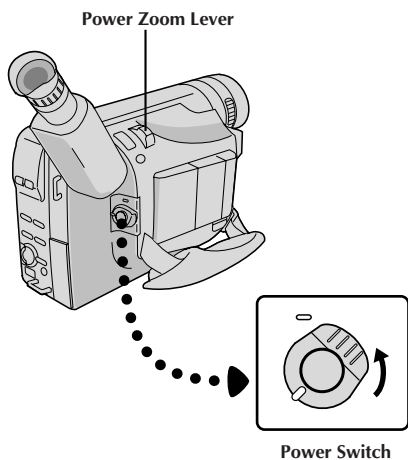
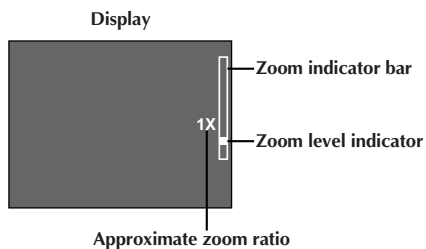
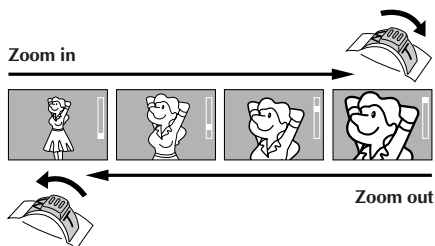

FEATURE: Zooming

PURPOSE:

To produce the zoom in/out effect, or an instantaneous change in image magnification.

Digital circuitry extends the maximum magnification offered by optical zoom. This system is called Digital Zoom.

OPERATION:

Zoom In

Push the Power Zoom Lever towards "T".

Zoom Out

Push the Power Zoom Lever towards "W".

- The quicker you push the Power Zoom Lever, the quicker the zoom action.

NOTES:

- Focusing may become unstable during Zooming. In this case, set the zoom while in Record-Standby, lock the focus by using the manual focus (☞ pg. 33), then zoom in or out in Record mode.
- The zoom level indicator (■) moves during zoom. Once the zoom level indicator reaches the top of the zoom indicator bar, all magnification from that point is through digital processing.
- When using Digital Zoom, the quality of image may suffer. To deactivate Digital Zoom, set "D.ZOOM" to "OFF" in the Menu Screen (☞ pg. 30).

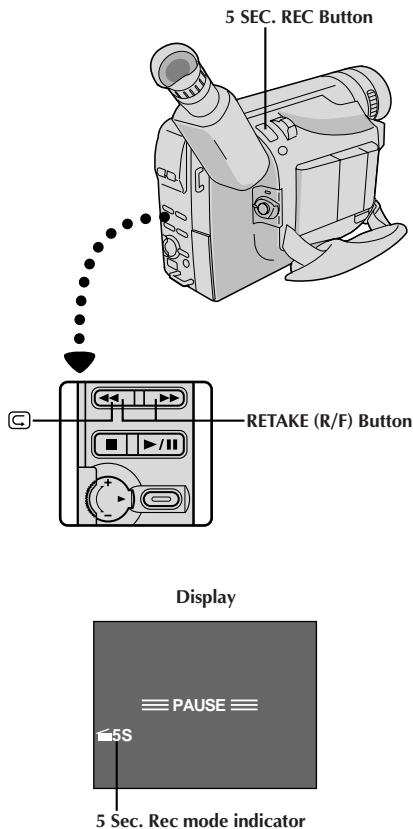

FEATURE: Quick Review

PURPOSE:

To check the end of the last recording.

OPERATION:

- 1) Press "⏮" and release quickly during the Record-Standby mode.
 - Tape is rewound for about 2 seconds and played back automatically, then pauses in Record-Standby mode for the next shot.

NOTE:

Distortion may occur at the start of playback. This is normal.

FEATURE: Retake

PURPOSE:

To re-record certain segments.

OPERATION:

- 1) Make sure the camcorder is in the Record-Standby mode.
- 2) Press either **RETAKE** to reach the start point for new recording. Pressing "F" forwards the tape and pressing "R" reverses it.
- 3) Press the Recording Start/Stop Button to start recording.

NOTE:

Noise bars appear and pictures may become monochrome or darken during Retake. This is normal.

FEATURE: 5 Sec. Rec (5-sec. Recording) (GR-AX857/AX657 only)

PURPOSE:

To record a scene for 5 seconds, providing quick scene transitions like those seen in TV programs.

OPERATION:

- Make sure the recording mode is set to "SP".
- 1) During Record-Standby, press **5 SEC. REC.** "5S" appears and 5 Sec. Rec is reserved.
 - 2) Press the Recording Start/Stop Button. Recording starts, and after 5-second recording is finished, the camcorder reenters the Record-Standby mode automatically.
 - To cancel the 5 Sec. Rec. function, press **5 SEC. REC** again so that "5S" disappears.

NOTE:

*Fade/Wipe (pg. 23) cannot be activated by pressing **5 SEC. REC.***

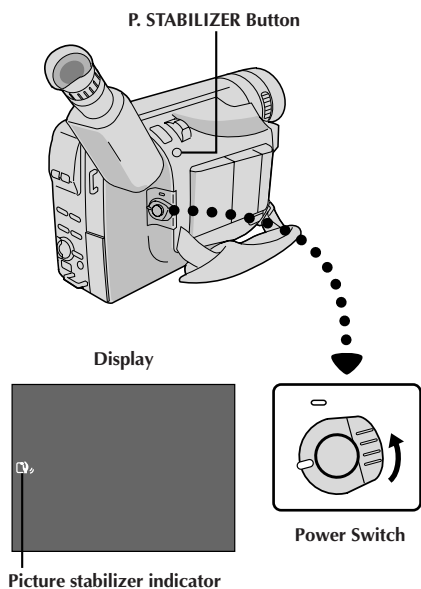
**FEATURE: Picture Stabilizer****PURPOSE:**

To compensate for unstable images caused by camera-shake, particularly at high magnification.

OPERATION:

- 1) Press **P. STABILIZER**. "📹", appears.
 - To switch off the Picture Stabilizer, press **P. STABILIZER**. The indicator disappears.

NOTES:

- Accurate stabilization may not be possible if hand shake is excessive, or under the following conditions:
 - When shooting subjects with vertical or horizontal stripes.
 - When shooting dark or dim subjects.
 - When shooting subjects with excessive backlighting.
 - When shooting scenes with movement in various directions.
 - When shooting scenes with low-contrast backgrounds.
- Switch off the Picture Stabilizer when recording with the camcorder on a tripod.
- The "📹" indicator appears blinking if the Stabilizer cannot be used.

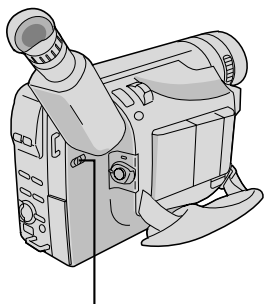

LIGHT OFF/AUTO/ON Switch

DANGER

- The video light can become extremely hot. Do not touch it either while in operation or soon after turning it off, otherwise serious injury may result.
- Do not place the camcorder into the carrying case immediately after using the video light, since it remains extremely hot for some time.
- When operating, keep a distance of about 30 cm. (1 ft.) between the video light and people or objects.
- Do not use near flammable or explosive materials.
- It is recommended that you consult your nearest JVC dealer for replacing the video light.

FEATURE: Video Light (GR-AX957/AX857 only)

PURPOSE:

To brighten the scene when natural lighting is too dim.

OPERATION:

1) Set the **LIGHT OFF/AUTO/ON** Switch as required:

OFF : Turns off the light.

AUTO : Automatically turns on the light when the camcorder senses insufficient lighting on the subject.

ON : Always keeps the light on as long as the camcorder is turned on.

- The video light can only be used with the camcorder's power on.
- It is recommended to set the white balance (☞ pg. 34) to when you use the video light.
- When not using the video light, turn it off to save battery power.

NOTES:

- Even if the battery indicator (☐) does not blink if the battery pack's charge is low, the camcorder may turn off automatically when you turn on the video light, or when you start recording with the video light turned on.
- When the **LIGHT OFF/AUTO/ON** Switch is set to "AUTO":
 - Depending on the lighting conditions, the video light may keep turning on and off. In this case, manually switch the light on or off using the **LIGHT OFF/AUTO/ON** switch.
 - While the "Sports" or "High Speed Shutter" mode (☞ pg. 25) is engaged, the light is likely to stay on.
 - While the "Twilight" mode (☞ pg. 25) is engaged, the light will not activate.

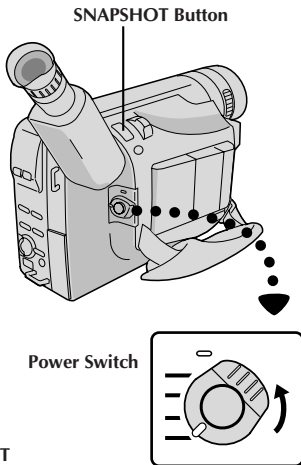

SNAPSHOT



Display

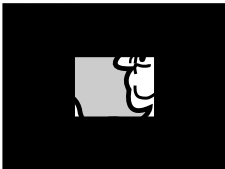
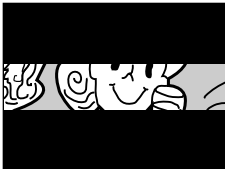

Snapshot (GR-AX957only)

Use your camcorder like a regular camera and take a snapshot, or several of them in succession.

1 SELECT OPERATION MODE

Set the Power Switch to "AUTO" or "PRO."

2 TAKE SNAPSHOT

Press SNAPSHOT.

If you press during Record-Standby . . .

.... a still image will be recorded for approx. 6 seconds, then the camcorder re-enters the Record-Standby mode.

If you press during Recording . . .

.... a still image will be recorded for approx. 6 seconds, then the normal recording resumes.

NOTE:

After **SNAPSHOT** is pressed, there is a momentary camera shutter-type blackout together with the sound effect of a shutter closing, which is recorded together with the image.

[Ex.: Fader]

Fade in



Fade out

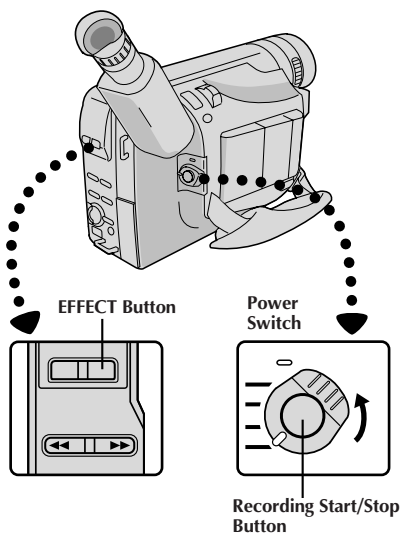
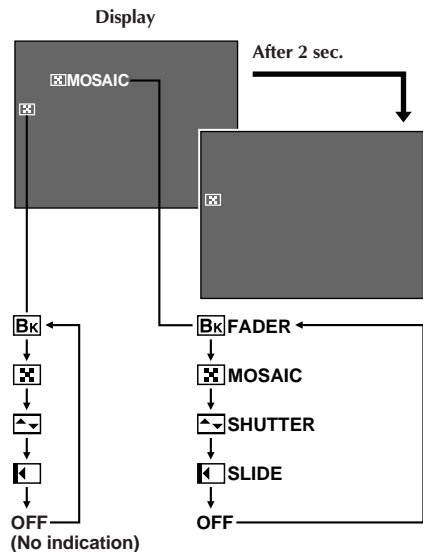

Fade/Wipe

These effects let you make pro-style scene transitions. Fade- or wipe-in works at recording start, and fade- or wipe-out works at recording end or when you enter Record-Standby mode.

1 SELECT OPERATION MODE

Set the Power Switch to "PRO."

2 ENGAGE FADE- OR WIPE-STANDBY MODE

Press **EFFECT** to cycle through the modes as shown at left. Once the desired mode appears, it is selected and reserved.

- The selected mode's name and its indication are displayed for approx. 2 seconds. Then the name disappears, and only the indication remains.

3 START OR END RECORDING

Press the Recording Start/Stop Button to activate fade-in/out or wipe-in/out.

4 TO CANCEL FADE- OR WIPE-STANDBY MODE

Press **EFFECT** repeatedly until "OFF" appears.

- "OFF" is displayed for approx. 2 seconds and the fade/wipe standby mode is canceled.

Bk FADER

Fades in/out to a black screen.

☒ MOSAIC (Fader)

Gradually turns/returns the picture into/from a mosaic pattern.

⬆ SHUTTER (Wipe)

A black screen moves in from the top and bottom, closing over the image like a shutter, or a new image pushes open the black screen vertically from the center.

◀ SLIDE (Wipe)

A black screen moves in from the left to gradually cover the image, or a new image moves in from right to left.

NOTES:

- Pressing and holding the Recording Start/Stop Button allows you to vary the length for the image during fade in/out or wipe in/out.
- The screen becomes slightly reddish when the Fade/Wipe is used with Sepia (☒ pg. 25).
- With the Electronic fog filter mode (☒ pg. 25) engaged, the image fades in/out to a white screen.

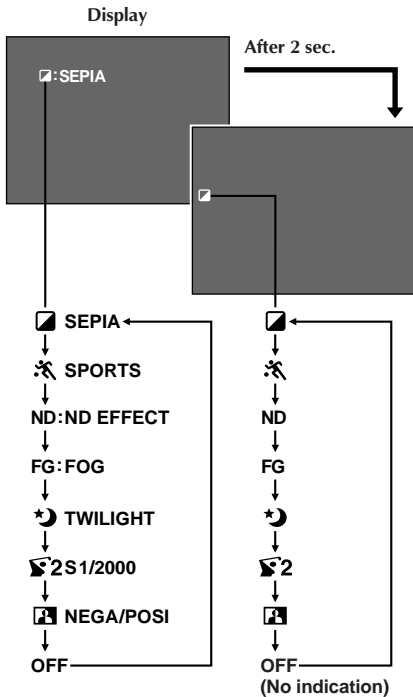

Program AE With Special Effects

All you have to do to access any of the variety of shooting effects is press **P.AE**.

1 SELECT OPERATION MODE

Set the Power Switch to "PRO."

2 SELECT MODE

Press **P.AE** to cycle through the modes as shown on the left.

- The selected mode's name and its indication are displayed for approx. 2 seconds. Then the name disappears, and only the indication remains. The mode is activated.

NOTES:

- Only one mode can be engaged at a time.
- The screen becomes slightly reddish when the Fade/Wipe (pg. 23) is used in the Sepia mode.
- The screen becomes slightly dark in the High Speed Shutter mode. Use in well-lit situations.
- In the "High Speed Shutter" or "Sports" modes, picture color may be adversely affected if the subject is lit by alternating discharge-type light sources such as fluorescent or mercury-vapor lights.

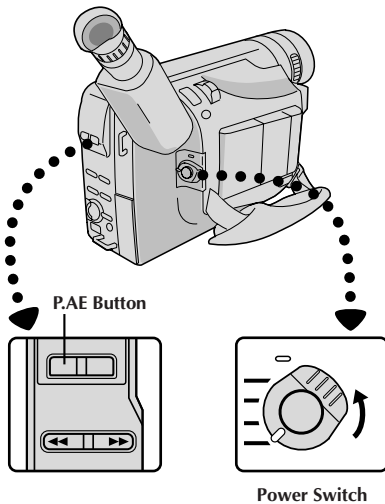

Display

Mode

**Sepia**

The scene being shot is recorded in sepia-tinted (reddish-brown) monochrome, giving the effect of an older movie. Use together with Wide (📖 pg. 29) for the authentic look of a classic Hollywood movie.

**Sports**

High shutter speed clearly captures fast-moving action.

**ND Effect**

A black mist darkens the picture, as when an ND filter is used. Helps to counter the effects of glare on the subject.

**Electronic Fog Filter**

Makes the picture look misty white, as when an external fog filter is attached to the lens. Softens the image and gives it a “fantasy” look.

**Twilight**

Dusk, twilight scenery, fireworks, etc., look more natural and dramatic. The following happens when Twilight mode is selected:

- Auto gain control is turned off.
- White Balance is set to “☀️” (FINE day mode), but can also be manually changed to another mode (📖 pg. 34).
- Auto Focus becomes available only in the range of 10 m (33 ft.) to infinity. To focus when the subject-to-camera distance is less than 10 m (33 ft.), use manual focusing (📖 pg. 32).

Display

Mode

**High-Speed Shutter (1/2000s.)**

Captures faster action than Sports mode.

**Nega/Posi (Negative/Positive)**

The colors of a picture are reversed.

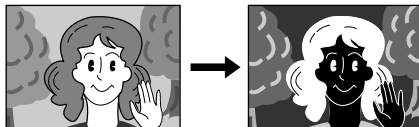

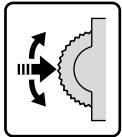
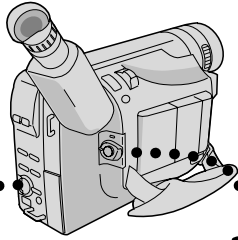

Select Dial

Display

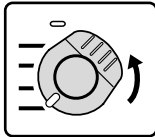

Power Switch

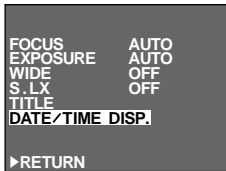

Menu Screen

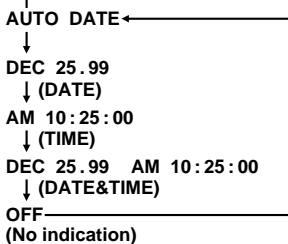
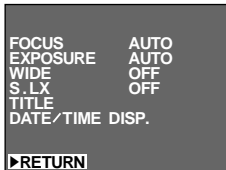
DATE/TIME DISP.
Menu

Date/Time Insert

This feature allows you to display the date and time in the viewfinder, or on a connected color monitor, as well as to record them manually or automatically.

1 SELECT OPERATION MODE

Set the Power Switch to "PRO."

2 ACCESS MENU SCREEN

Press the Select Dial to display the Menu Screen.

3 ACCESS "DATE/TIME DISP." MENU

Move the highlight bar to "DATE/TIME DISP." by rotating the Select Dial while in Record-Standby. Then press it to display the DATE/TIME DISP. Menu.

4 SELECT THE DESIRED MODE

Move the highlight bar to the desired mode by rotating the Select Dial, then press it. The desired mode is activated.

- You should have already performed the Date/Time Setting procedure (☞ pg. 11). If you haven't, do so first.

5 CLOSE MENU SCREEN

The Menu Screen reappears with the highlight bar on "RETURN". Then press the Select Dial to close the Menu Screen.

NOTES:

DISPLAY

- The selected display can be recorded.
- If you do not want to record the display, select the OFF mode before shooting.

AUTO DATE

- Your camcorder automatically records the date for about 5 seconds after recording is initiated in the following situations:
 - After changing the date.
 - After loading a cassette.
 - After Auto Date Record mode is selected by rotating the Select Dial.
- In this mode, the date is replaced after 5 seconds with "AUTO DATE" but this is not recorded.

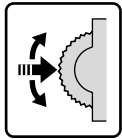
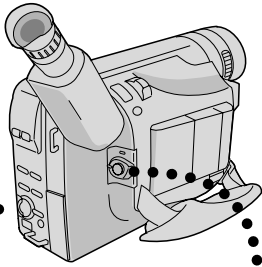

Select Dial

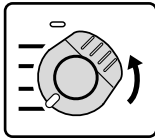

Power Switch

Display

FOCUS AUTO
EXPOSURE AUTO
WIDE OFF
S.LX OFF
TITLE
DATE/TIME DISP.

▶RETURN

Menu Screen

OFF TITLE
HAPPY BIRTHDAY
OUR VACATION
MERRY CHRISTMAS
A SPECIAL DAY
HAPPY HOLIDAYS
OUR NEW BABY
WEDDING DAY
CONGRATULATIONS
EXIT

TITLE Menu

FOCUS AUTO
EXPOSURE AUTO
WIDE OFF
S.LX OFF
TITLE
DATE/TIME DISP.

▶RETURN

CONGRATULATIONS

Instant Titles

The camcorder has eight preset titles in memory. You can superimpose one of them above a previously stored title as shown in the illustration to the left.

Instant Titles can be displayed not only in English but also in French, Spanish and Portuguese. Change the setting in TITLE LANG. in the Menu Screen. (▶ pg. 28, 30).

1 SELECT OPERATION MODE

Set the Power Switch to "PRO."

2 ACCESS MENU SCREEN

Press the Select Dial to display the Menu Screen.

3 ACCESS "TITLE" MENU

Move the highlight bar to "TITLE" by rotating the Select Dial while in Record-Standby. Then press it to display the TITLE Menu.

4 SELECT THE DESIRED MODE

Move the highlight bar to the desired mode by rotating the Select Dial, then press it. The desired mode is activated.

- If you wish to make the title indication disappear, select "OFF".

5 CLOSE MENU SCREEN

The Menu Screen reappears with the highlight bar on "RETURN". Then press the Select Dial to close the Menu Screen.

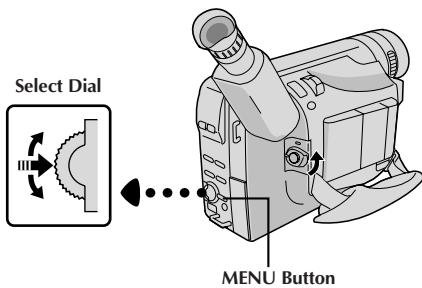

Display
(ex. Menu Screen available
using the MENU Button)

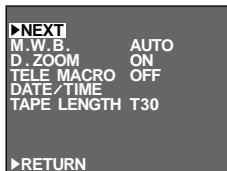

Menu Screen 1

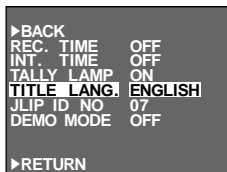

Menu Screen 2

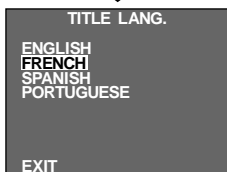
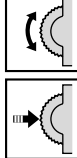
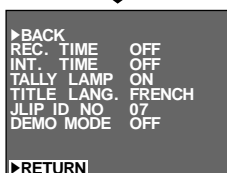
Setting Menu
(ex. TITLE LANG.)

Normal Screen



Using Menu For Detailed Adjustment

This camcorder is equipped with an easy-to-use, on-screen menu system that simplifies many of the more detailed camcorder settings.

1 SELECT OPERATION MODE

Turn the Power Switch to "PRO".

2 ACCESS MENU SCREEN

Menu access depends on the function you select.

If you select the functions from the "Menu Screen Available Using The Select Dial" described on pg. 29 . . .

.... press the Select Dial. The Menu Screen appears.

If you select the functions from the "Menu Screen Available Using The MENU Button" described on pg. 29 and 30 . . .

.... press MENU. The Menu Screen appears.

3 SELECT FUNCTION

Rotate the Select Dial to place the highlight bar on the desired function.

- To go from Menu Screen 1 to Menu Screen 2, rotate the Select Dial to "NEXT" and press it. To go back to Menu Screen 1 from Menu Screen 2, rotate the Select Dial to "BACK", and press it.

- If the setting you want cannot be found in the Menu Screen, place the highlight bar on "RETURN", then go to step 6.

4 MAKE SETTING

Press the Select Dial. The setting procedure depends on the function you select.

If you select "FOCUS", "EXPOSURE", "TITLE", "DATE/TIME DISP." or "DATE/TIME" . . .

.... see respective pages (FOCUS: pg. 32, 33, EXPOSURE: pg. 31, TITLE: pg. 27, DATE/TIME DISP.: pg. 26, DATE/TIME: pg. 11).

If you select "WIDE", "D.ZOOM", "TELE MACRO" or "DEMO MODE" . . .

.... the selected function's parameter starts blinking.

Rotate the Select Dial until the desired parameter appears. Go to step 5.

If you select "JLIP ID NO." . . .

.... press the Select Dial so that the number blinks, then rotate it until the desired number appears, and press it. Then rotate the Select Dial to move the highlight bar to "EXIT".

If you select any other functions . . .

.... rotate the Select Dial to move the highlight bar to the desired setting.

- If you decide you want to return to the previous setting, rotate the Select Dial to move the highlight bar to "EXIT".

5 END SETTING

Press the Select Dial. The Menu Screen reappears with the highlight bar on "RETURN".

6 CLOSE MENU SCREEN

Press the Select Dial. The normal screen reappears.

NOTE:

No menu functions except "FOCUS" and "EXPOSURE" are available while in the Record mode.



MENU SCREEN EXPLANATIONS

Menu Screen Available Using The Select Dial

FOCUS	AUTO	Adjusts focus automatically.
	MANU	Allows you to adjust focus manually (☞ pg. 32, 33).
EXPOSURE	AUTO	Adjusts exposure automatically.
	MANU	Allows you to adjust exposure manually (☞ pg. 31).
WIDE	OFF	Does not display black bars.
	ON	Allows you to record black bars at the top and bottom of the screen to produce a cinema-like “wide-screen” effect. If a snapshot (☞ pg. 22) is taken while the camcorder is in the WIDE mode, the snapshot image is recorded using NORMAL mode without the black bars at the top and bottom of the screen.
S.LX	MAX	To record a subject in a darkly lit environment, when it is more convenient to shoot the subject with a brighter image even if the picture becomes slightly coarse.
	NORMAL	To record a subject in a dimly lit environment, when it is more convenient to shoot with a less coarse picture although the subject becomes slightly dark. This setting is suitable for measuring sensitivity conforming to EIA-639 (EIA* Standard for Low Light Sensitivity Measurement). *EIA : Electronic Industries Alliance
	OFF	Allows you to shoot dark scenes with no picture brightness adjustment.
TITLE	Allows you to superimpose one of eight preset titles (☞ pg. 27).	
DATE/TIME DISP.	Makes the date/time settings appear in the camcorder or on a connected monitor (☞ pg. 26).	

Menu Screen Available Using The MENU Button

This Menu Screen cannot be accessed while recording.

M.W.B.	AUTO	This camcorder's Automatic Color Temperature system senses the color temperature of the ambient lighting for automatic white balance adjustment. However, precise color adjustment is not possible under the following conditions: <ul style="list-style-type: none"> • When an object is in various shades of the same color. • When a predominantly red or brown object is being shot outdoors. In these cases, use the camcorder's built-in preset filters for white balance adjustment (☞ pg. 34, 35).
	 : FINE	
	 : CLOUD	
	 : HALOGEN	
	MWB	
D. ZOOM	ON	Allows you to use the Digital Zoom. By digitally processing and magnifying images, zooming is possible from 16 times (the optical zoom limit), to a maximum of 380 times (GR-AX957)/50 times (GR-AX857/AX657) digital magnification.
	OFF	Digital Zoom is not available. Only optical zoom (maximum 16x magnification) can function. When set to “OFF” during Digital Zoom, zoom magnification changes to 16x.
TELE MACRO	OFF	Usually the distance to a subject where the lens is in focus depends on the zoom magnification. Unless there is a distance of more than 1m (3.3 ft.) to the subject, the lens is out of focus at the maximum telephoto setting. When set to “ON”, you can shoot a subject as large as possible at a distance of approx. 60 cm (2 ft.). <ul style="list-style-type: none"> • Depending on the zoom position, the lens may go out of focus.
	ON	

Menu Screen Available Using The MENU Button (cont.)

DATE/TIME	Allows you to set the current date and time (☞ pg. 11).	
TAPE LENGTH	Allows you to set the tape length depending on the tape used (☞ pg. 12).	
REC TIME	This feature allows you to set the parameters for Animation and Time-Lapse recording (☞ pg. 37).	
INT. TIME	This feature allows you to set the parameters for Self-Timer (☞ pg. 36) and Time-Lapse recording (☞ pg. 36, 37).	
TALLY LAMP	ON	The tally lamp comes on to signal the start of recording.
	OFF	The tally lamp remains off at all times.
TITLE LANG.	Allows you to select the language (ENGLISH, FRENCH, SPANISH or PORTUGUESE) of Instant Titles (☞ pg. 27).	
JLIP ID NO.	This number is necessary when connecting the camcorder to a device such as a computer using the J terminal (JLIP). The numbers range from 01 to 99. Factory setting is 07.	
DEMO MODE	OFF	Automatic demonstration will not take place.
	ON	<p>Demonstrates certain functions such as Fade/Wipe, etc. When "DEMO MODE" is set to "ON" and the Menu Screen is closed, the demonstration starts.</p> <p>NOTES:</p> <ul style="list-style-type: none"> ● When a tape whose Erase Protection tab is in the position that allows recording is loaded in the camcorder, demonstration is not available. ● By turning off the camcorder or inserting a tape whose Erase Protection tab is in the position that allows recording into it, "DEMO MODE" is set to "OFF" automatically. ● During the demonstration, all functions except zoom are disabled.

 : Factory-preset

Exposure Control

This feature automatically adjusts the iris for the best available picture quality, but you can override and make the adjustment manually.

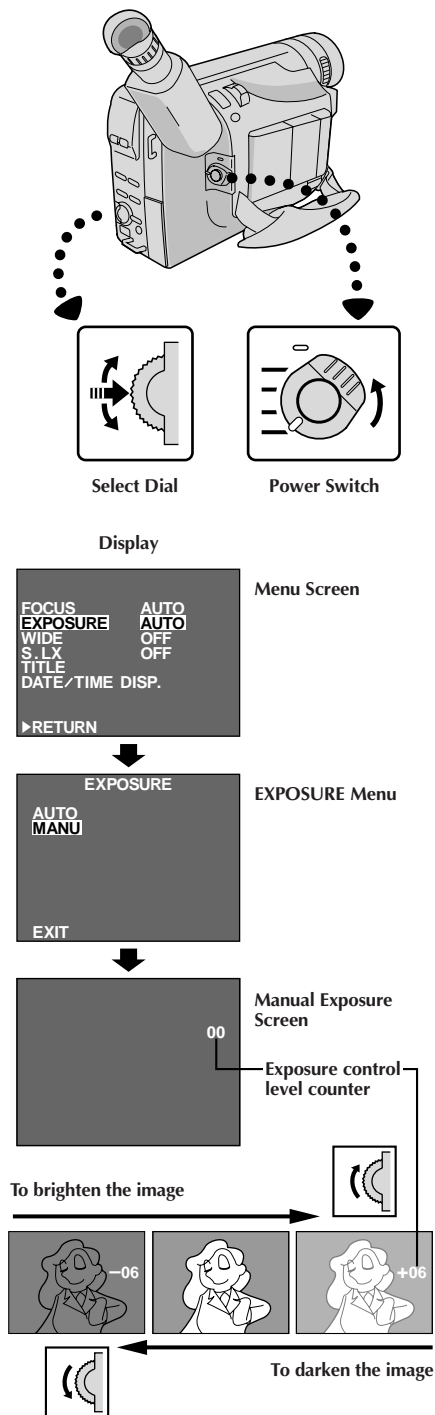

1 SELECT OPERATION MODE

Set the Power Switch to "PRO."

2 ACCESS MENU SCREEN

Press the Select Dial to display the Menu Screen.

3 ACCESS "EXPOSURE" MENU

Rotate the Select Dial to move the highlight bar to "EXPOSURE" and press it.

4 ACCESS MANUAL EXPOSURE

Rotate the Select Dial to move the highlight bar to "MANU", then press it. "00" (exposure control level counter) appears.

5 ADJUST EXPOSURE

To brighten the image . . .

.... rotate the Select Dial upward. The exposure control level counter increases (maximum +06).
Go to step 6.

To darken the image . . .

.... rotate the Select Dial downward. The exposure control level counter decreases (maximum -06).
Go to step 6.

6 END ADJUSTMENT OF EXPOSURE

Press the Select Dial. The Menu Screen reappears with the highlight bar on "RETURN".

7 CLOSE MENU SCREEN

Press the Select Dial. The Menu Screen disappears and the exposure control level counter reappears to indicate the exposure is adjusted.

NOTES:

- To return to the factory setting, select "AUTO" in step 4.
- To re-adjust exposure, repeat the procedure from step 2.

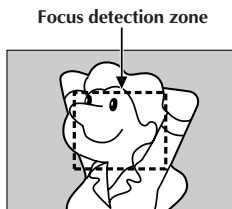

Focusing

AUTO FOCUS

The camcorder's Full Range AF system offers continuous shooting ability from close-up to infinity. However, correct focus may not be obtainable in the situations listed below (in these cases use manual focusing):

- When two subjects overlap in the same scene.
- When illumination is low.*
- When the subject has no contrast (difference in brightness and darkness), such as a flat, one-color wall, or a clear, blue sky.*
- When a dark object is barely visible in the viewfinder.*
- When the scene contains minute patterns or identical patterns that are regularly repeated.
- When the scene is affected by sunbeams or light reflecting off the surface of a body of water.
- When shooting a scene with a high-contrast background.

* The low-contrast warning "▲▲" appears.

NOTES:

- If the lens is smeared or blurred, accurate focusing is not possible. Keep the lens clean, wiping with a piece of soft cloth if it gets dirty. When condensation occurs, wipe with a soft cloth or wait for it to dry naturally.
- When shooting a subject close to the lens, zoom out first (☞ pg. 18). If zoomed in in the auto focus mode, the camcorder could automatically zoom out depending on the distance between the camcorder and the subject. When Tele Macro (☞ pg. 29) is activated, the camcorder will not zoom out automatically.

MANUAL FOCUS

NOTE:

You should already have made the necessary viewfinder adjustments (☞ pg. 14). If you haven't, do so before continuing.

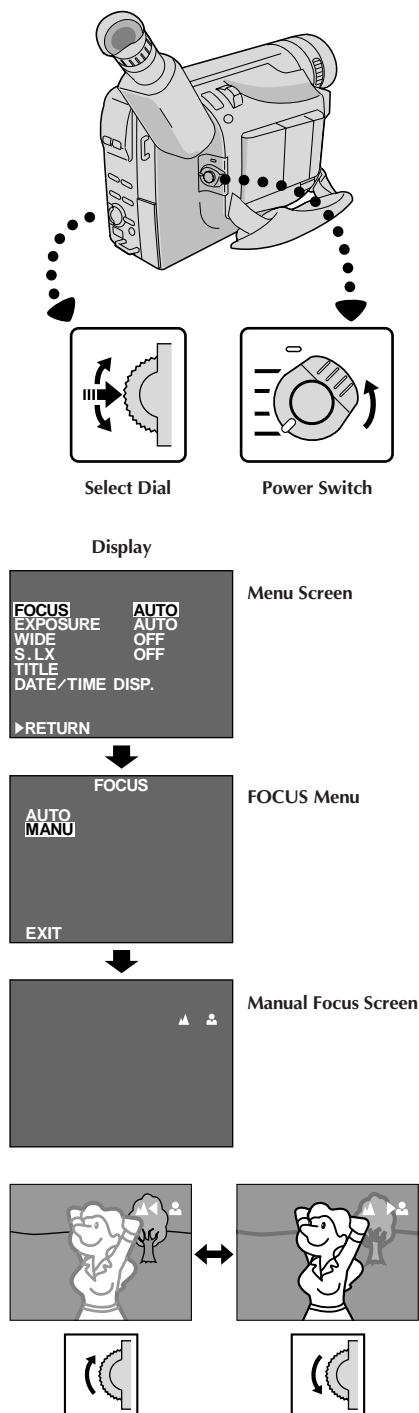
**1 SELECT OPERATION MODE**

Set the Power Switch to "PRO."

2 ACCESS MENU SCREEN

Press the Select Dial to display the Menu Screen.

3 ACCESS "FOCUS" MENU

Move the highlight bar to "FOCUS" by rotating the Select Dial, then press it.

4 ACCESS MANUAL FOCUS

Rotate the Select Dial to move the highlight bar to "MANU", then press it. "▲" and "●" appear. The focus is locked at this point.

5 ADJUST FOCUS

To farther subject . . .

.... rotate the Select Dial upward. "◀" appears and blinks.

Go to step 6.

To nearer subject . . .

.... rotate the Select Dial downward. "▶" appears and blinks.

Go to step 6.

6 END ADJUSTMENT OF FOCUS

Press the Select Dial. The Menu Screen reappears with the highlight bar on "RETURN".

7 CLOSE MENU SCREEN

Press the Select Dial. The Menu Screen disappears and "▲●" reappears to indicate the focus is locked.

NOTES:

- To return to Auto Focus, select "AUTO" in step 4.
- To re-adjust Manual Focus, repeat the procedure from step 2.
- Be sure to focus the lens in the maximum telephoto position when you use the Manual Focus mode. If you focus in on a certain subject in the wide-angle position, sharply focused images cannot be obtained when zoomed in because the depth-of-field is reduced at longer focal lengths.
- When the focus level cannot be adjusted any farther or closer, "▲" or "●" will blink.

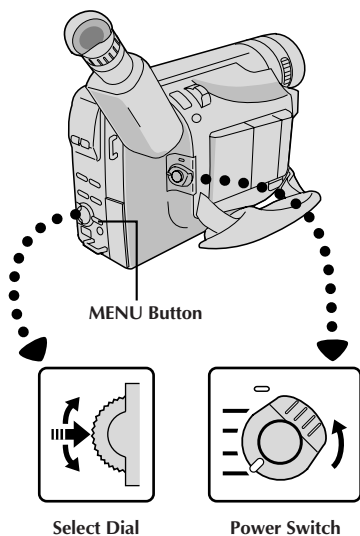

Select Dial

Power Switch

Display

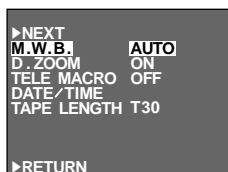

Menu Screen

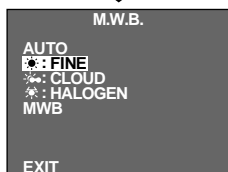

M.W.B. Menu

White Balance Adjustment

A term that refers to the correctness of color reproduction under various lighting. If the white balance is correct, all other colors will be accurately reproduced.

The white balance is usually adjusted automatically. However, the more advanced camcorder operator would prefer to control this function manually and achieve a more professional color/tint reproduction.

1 SELECT OPERATION MODE

Set the Power Switch to "PRO."

2 ACCESS MENU SCREEN

Press MENU. The Menu Screen appears.

3 ACCESS WHITE BALANCE ADJUSTMENT

Move the highlight bar to "M.W.B." by rotating the Select Dial, then press it. The Menu Screen disappears and the M.W.B. Menu appears.

4 SET FUNCTION PARAMETERS

Move the highlight bar to the required white balance by rotating the Select Dial.

"AUTO"

The white balance is adjusted automatically. This is the factory preset position.

☀️ : FINE"

When shooting outdoors on a sunny day.

☁️ : CLOUD"

When shooting outdoors on a cloudy day.

🔦 : HALOGEN"

When using a video light or other similar type of lighting.

"MWB"

When shooting with the white balance already having been set on the subject (☞ pg. 35).

5 CLOSE MENU SCREEN

Press the Select Dial. The Menu Screen reappears with the highlight bar on "RETURN". Press the Select Dial again to close the Menu Screen.

To Return To Automatic White Balance . . .

.... select "AUTO" in step 4. Or set the Power Switch to "AUTO".

NOTE:

White balance cannot be used when Sepia (☞ pg. 25) is activated.

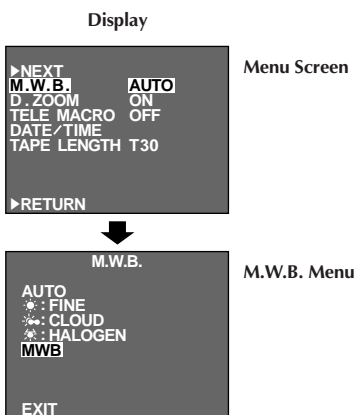
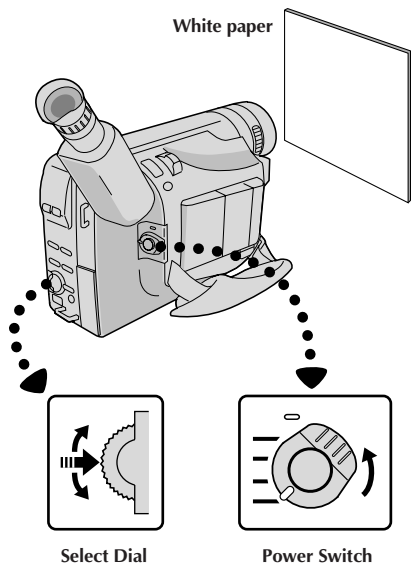

Manual White Balance Operation

If the camera is operating in PRO. mode, perform a Manual White Balance when shooting under various types of lighting.

- 1 SELECT OPERATION MODE**
Follow steps 1 through 4 of the white balance adjustment (☞ pg. 34), and select "MWB".
- 2 SET MANUAL WHITE BALANCE**
Hold a sheet of plain white paper in front of the subject. Adjust zoom or position yourself so that the white paper fills the screen.
- 3 ENTER SETTING**
Press the Select Dial until "MWB" begins blinking.
 - When the setting is completed, "MWB" stops blinking, and the Menu Screen reappears with the highlight bar on "RETURN".
- 4 CLOSE MENU SCREEN**
Press the Select Dial again to close the Menu Screen.

To Change The Tint For Recording . . .

.... in step 2, substitute colored paper for white. The white balance is adjusted based on the color, changing the tint. Red paper — deeper green; blue paper — orange; yellow paper — deeper purple.

NOTES:

- In step 2, it may be difficult to focus on the white paper in some circumstances. In such a case, adjust focus manually (☞ pg. 33).
- A subject can be shot under various types of lighting conditions indoors (natural, fluorescent, candlelight, etc.). Because the color temperature is different depending on the light source, the tint of the subject will differ depending on the white balance settings. Use this function for a more natural result.
- Once you adjust white balance during Manual White Balance operation, the setting is retained even if the power is turned off or the battery removed.

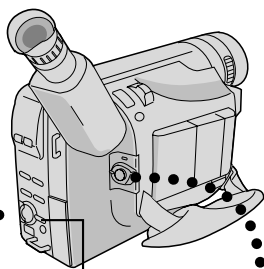

MENU Button

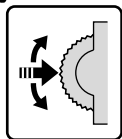

Select Dial

Display

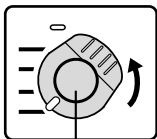

Recording Start/Stop Button

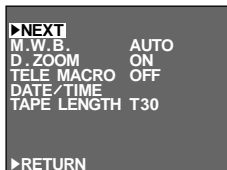

Menu Screen 1



Menu Screen 2



INT. TIME Menu



REC TIME Menu

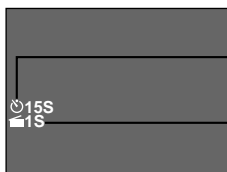

INT. TIME indicator

REC TIME indicator

INT. TIME and REC TIME indications on the normal screen

Self-Timer

You can set the delay between pressing the Recording Start/Stop button and the actual start of recording. If you secure the camcorder, you (or whoever is operating the camcorder) can enter the scene before recording starts.

NOTE:

Make sure the Power Switch is set to "PRO." and the camcorder is in the Record-Standby mode before performing the following steps.

1 ACCESS MENU SCREEN

Press MENU.

2 ACCESS "INT. TIME" MENU

Rotate the Select Dial to move the highlight bar to "NEXT" in Menu Screen 1 and press it to display Menu Screen 2. Then, move the highlight bar to "INT. TIME" and press it.

3 SET INTERVAL TIME

Rotate the Select Dial to move the highlight bar to the desired time, then press it. The Menu Screen reappears with the highlight bar on "RETURN".

4 CLOSE MENU SCREEN

Press the Select Dial.

5 START DELAYED RECORDING

Press the Recording Start/Stop Button. When the selected time has elapsed, recording begins automatically.

To Cancel Self-Timer . . .

.... Before the recording begins, press the Recording Start/Stop Button to display "≡PAUSE≡", then set "INT. TIME" in the Menu Screen to "OFF".

Animation

You can give stationary scenes or objects an illusion of movement. This function allows you to shoot a series of pictures, each slightly different, of the same object for a brief period of time.

NOTE:

Before performing the following steps, make sure that:

- The Power Switch is set to "PRO."
- The camcorder is in the Record-Standby mode.
- The recording mode is set to "SP".

1 ACCESS MENU SCREEN

Press MENU.

2 SET RECORDING TIME

Rotate the Select Dial to move the highlight bar to "NEXT" in Menu Screen 1 and press it to display Menu Screen 2. Then, move the highlight bar to "REC TIME" and press it. The REC TIME Menu appears. Rotate the Select Dial to move the highlight bar to the desired time, then press it. The Menu Screen reappears with the highlight bar on "RETURN". Press the Select Dial again to close the Menu Screen.

3 START RECORDING

Press the Recording Start/Stop Button after focusing on the subject. The recording stops automatically after the selected period of time.

4 ASSEMBLE SERIES OF PICTURES

Repeat step 3 for the desired number of pictures.

5 RELEASE ANIMATION MODE

Set "REC TIME" in the Menu screen to "OFF".

NOTES:

- For best results, make sure the camcorder is secured when shooting in Animation or Time-Lapse mode.
- Fade- or wipe-in/out cannot be performed during Animation or Time-Lapse shooting.
- Before performing other operations following Animation or Time-Lapse recording, make sure the Animation or Time-Lapse mode is deactivated.
- Self-Timer, Animation and Time-Lapse are canceled when the power is shut off or when the cassette is ejected.

Time-Lapse

You can record sequentially at preset time spans. Leaving the camcorder aimed at a specific subject, you can record subtle changes over an extended period of time.

NOTE:

Before performing the following steps, make sure that:

- The Power Switch is set to "PRO."
- The camcorder is in the Record-Standby mode.
- The recording mode is set to "SP".

1 ACCESS MENU SCREEN

Press MENU.

2 SET INTERVAL BETWEEN RECORDINGS

Rotate the Select Dial to move the highlight bar to "NEXT" in Menu Screen 1 and press it to display Menu Screen 2. Then, move the highlight bar to "INT. TIME" and press it. The INT. TIME Menu appears. Rotate the Select Dial to move the highlight bar to the desired time, then press it. The Menu Screen reappears.

3 SET RECORDING TIME

Rotate the Select Dial to move the highlight bar to "REC TIME", then press it. The REC TIME Menu appears. Rotate the Select Dial to move the highlight bar to the desired time, then press it. The Menu Screen reappears with the highlight bar on "RETURN". Press the Select Dial again to close the Menu Screen.

4 START TIME-LAPSE RECORDING

Press the Recording Start/Stop Button. Recording and intervals alternate automatically.

5 RELEASE TIME-LAPSE MODE

To release when "≡PAUSE≡" is displayed, set "REC TIME" and "INT. TIME" in the Menu Screen to "OFF". To release when "≡PAUSE≡" and "REC" are not displayed, press the Recording Start/Stop Button to display "≡PAUSE≡", then set "REC TIME" and "INT. TIME" in the Menu Screen to "OFF".

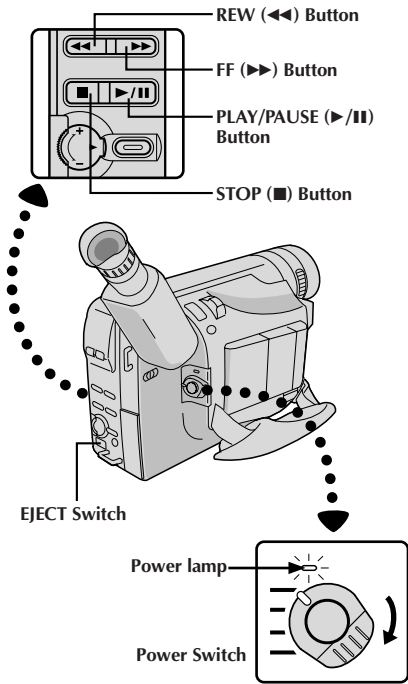

1 LOAD A CASSETTE

Slide **EJECT** to open the cassette holder, then insert the cassette with the label facing out. Press **PUSH** to ensure the holder is closed and locked.

2 SELECT MODE

Set the Power Switch to "PLAY". The power lamp lights.

3 PLAY BACK

Press **PLAY/PAUSE (▶/||)**. The playback picture appears.

4 STOP PLAYBACK

Press **STOP (■)**.

Rewind or Fast-Forward the tape

Press **REW (◀◀)** to rewind, or **FF (▶▶)** to fast-forward the tape during Stop mode.

NOTES:

- The camcorder shuts off automatically after about 5 minutes in Stop mode. To turn on again, set the Power Switch to "POWER OFF", then to "PLAY".
- If a blank portion on the tape is played back, the screen may become black. This is not a malfunction.

Battery pack remaining power indicator

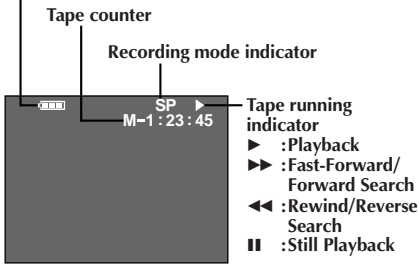

Viewfinder indications

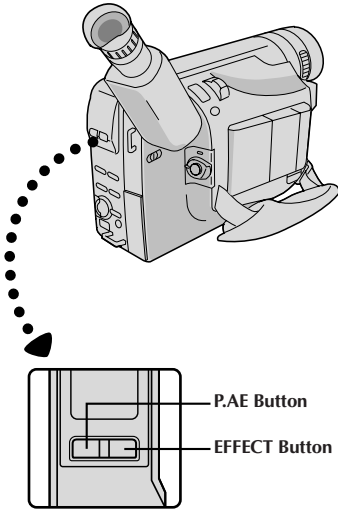

Tracking

This function can be used to eliminate noise bars that appear on-screen during playback. Initial setting is Auto Tracking. Manual Tracking is also available.

1 ACTIVATE MANUAL TRACKING

Press **P.AE** and **EFFECT** simultaneously. Then, press **P.AE** or **EFFECT** as many times as necessary until the noise bars disappear.

- To return to Auto Tracking, press **P.AE** and **EFFECT** simultaneously. "AT" blinks. When Auto Tracking finishes, the indication disappears.

NOTES:

- When noise bars appear during playback, the camcorder enters the Auto Tracking mode and "AT" is displayed.
- Manual Tracking may not work with tapes recorded on other VCRs or camcorders.

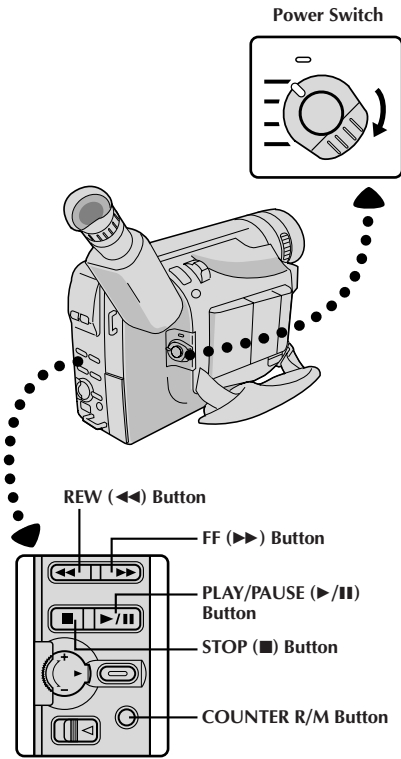
**FEATURE: Still Playback****PURPOSE:**

To pause during playback.

OPERATION:

- 1) Press **PLAY/PAUSE** (▶/||) during playback.
- 2) To resume normal playback, press **PLAY/PAUSE** (▶/||) again.

NOTE:

Noise bars appear and pictures may become monochrome during Still Playback. This is normal.

FEATURE: Shuttle Search**PURPOSE:**

To allow high-speed search in either direction.

OPERATION:

- 1) Press **FF** (▶▶) to search forward or press **REW** (◀◀) to reverse during playback.
- 2) To resume normal playback, press **PLAY/PAUSE** (▶/||).

NOTES:

- During playback, press and hold **REW** (◀◀) or **FF** (▶▶). The search continues as long as you hold the button. Once you release it, normal playback resumes.
- Noise bars appear and pictures may become monochrome or darken during Shuttle Search. This is normal.

FEATURE: Counter Memory Function**PURPOSE:**

To make it easier to locate a specific tape segment.

OPERATION:

- 1) Press **COUNTER R/M** and hold for more than 1 second. The counter resets to "0:00:00".
- 2) Press **COUNTER R/M** for less than 1 second. "M" appears.
- 3) After recording or playback, press **STOP** (■), then **REW** (◀◀). The tape automatically stops at or close to 0:00:00.
- 4) Press **PLAY/PAUSE** (▶/||) to start playback.

NOTES:

- The counter memory functions in the Fast-Forward and Rewind modes.
- To disable the Counter Memory Function, press **COUNTER R/M** for less than 1 second so that "M" disappears.

Cassette Adapter (VHS Playpak)

Use this to play back a VHS-C video cassette recorded with this camcorder on a VHS VCR. It is fully compatible with any VHS video cassette recorder. The C-P7U adapter is battery powered and automatically performs tape loading and unloading.

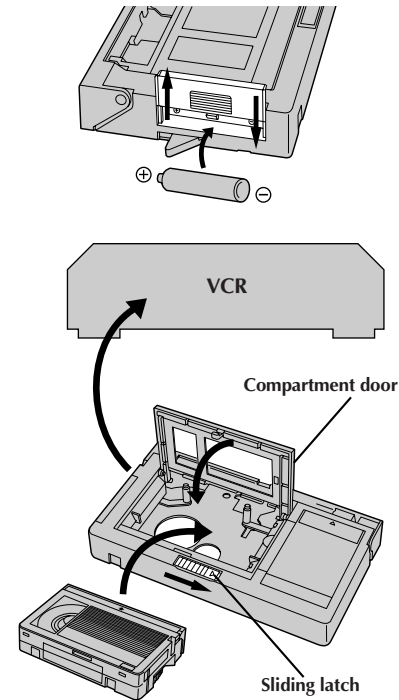

Compact video cassette

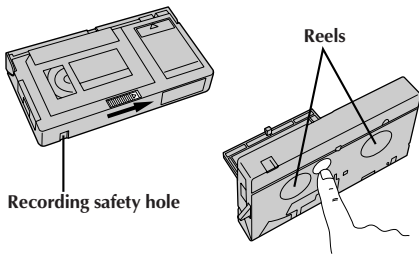

Recording safety hole

Reels

1 INSERT BATTERY

Slide the battery cover up to remove it, and install one "AA(R6)" size battery as shown in the illustration at left, then reattach the cover.

2 INSERT CASSETTE IN ADAPTER

Slide the latch to open the adapter compartment door, then insert the cassette and close the compartment door.

3 PLAY BACK ON CONNECTED VCR

Load the cassette adapter into the VCR and play the tape back as you would any other.

4 REMOVE CASSETTE FROM ADAPTER

Slide the latch and the compartment door opens automatically. This may take around 10 seconds. Do not attempt to force the adapter open. Then, insert your finger in the hole on the underside of the adapter as shown in the illustration at left, and push up and remove the cassette.

NOTES:

- During tape loading and unloading, do not touch the reels for safety and tape protection.
- During special-effect playback (slow motion, still frame, etc.), the picture may vibrate or noise bars may appear on the screen.
- To record on a VCR using a compact cassette and the adapter, cover the adapter's recording safety hole with adhesive tape.

These are some basic types of connections. When making connections, refer also to your VCR and TV instruction manuals.

Basic Connections

Use optional Video and Audio cables.

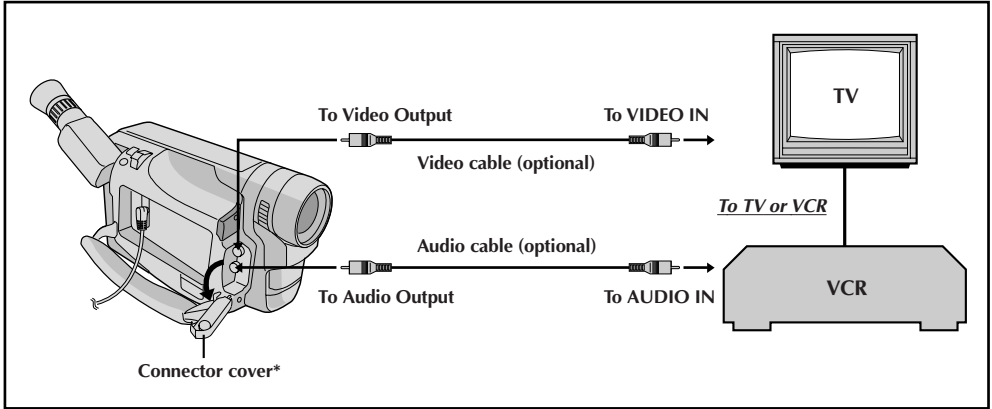

Connection For Tape Dubbing

Use optional Video and Audio cables.

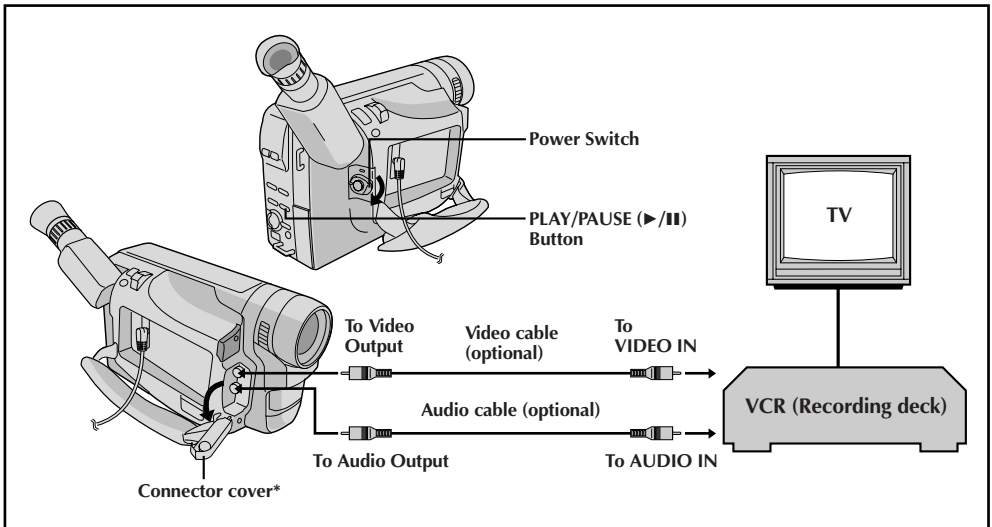

* When connecting the cables, open this cover.

Basic Connections

- 1 CONFIRM POWER-OFF STATUS**
Make sure the camcorder's power is off.
- 2 CONNECT CAMCORDER TO TV OR VCR**
Pull out the connector cover and open it.
Connect as shown in the illustration (☞ pg. 42).
If using a VCR . . . go to step 3.
If not . . . go to step 4.
- 3 CONNECT VCR OUTPUT TO TV INPUT**
Refer to your VCR's instruction manual.
- 4 SUPPLY POWER**
Turn on the camcorder, the VCR and the TV.
- 5 SELECT MODE**
Set the VCR to its AUX input mode, and set the TV to its VIDEO mode.

NOTES:

- *It is recommended to use the AC Power Adapter/Charger as the power supply instead of the battery pack (☞ pg. 9).*
- *To monitor the picture and sound from the camcorder without inserting a tape, set the camcorder's Power Switch to "CAMERA" ("AUTO" or "PRO."), then set your TV to the appropriate input mode.*
- *Make sure you adjust the TV sound volume to its minimum level to avoid a sudden burst of sound when the camcorder is turned on.*
- *If you have a TV or speakers that are not specially shielded, do not place the speakers adjacent to the TV as interference will occur in the camcorder playback picture.*

Tape Dubbing

- 1 CONNECT EQUIPMENT**
Following the illustration on pg. 42, connect the camcorder and the VCR.
- 2 PREPARE FOR DUBBING**
Set the camcorder's Power Switch to "PLAY", turn on the VCR's power, and insert the appropriate cassettes in the camcorder and the VCR.
- 3 SELECT VCR MODE**
Engage the VCR's AUX and Record-Pause modes.
- 4 FIND EDIT-IN POINT**
Engage the camcorder's Play mode to find a spot just before the edit-in point. Once it is reached, press **PLAY/PAUSE** (▶/||) on the camcorder.
- 5 START EDITING**
Press **PLAY/PAUSE** (▶/||) on the camcorder and engage the VCR's Record mode.
- 6 STOP EDITING TEMPORARILY**
Engage the VCR's Record-Pause mode and press **PLAY/PAUSE** (▶/||) on the camcorder.
- 7 EDIT MORE SEGMENTS**
Repeat steps 4 through 6 for additional editing, then stop the VCR and camcorder when finished.

The Full-Function Remote Control Unit can operate this camcorder from a distance as well as the basic operations (Playback, Stop, Pause, Fast-Forward and Rewind) of your VCR.

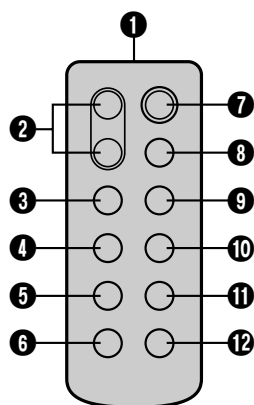

RM-V705U
(provided with GR-AX957/AX857,
optional for GR-AX657)

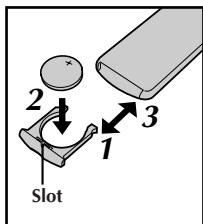

Installing The Battery

The remote control uses one lithium battery (CR2025).

- 1 PULL OUT BATTERY HOLDER**
Pull out the battery holder by inserting a pointed instrument into the slot.
- 2 INSERT BATTERY IN HOLDER**
Insert the battery in the holder, and be sure to have the “+” mark visible.
- 3 RE-INSERT HOLDER**
Slide the holder back in until you hear a click.
 - Read the caution concerning lithium batteries (☞ pg. 2).

Buttons	Functions	
	With the camcorder's Power Switch set to "CAMERA", "AUTO" or "PRO."	With the camcorder's Power Switch set to "PLAY".
1 Infrared beam transmitting window	Transmits the beam signal.	
2 ZOOM (T/W) Buttons	Zoom in/out (☞ pg. 18)	—
3 PLAY Button	—	Playback start (☞ pg. 38)
4 STOP Button	—	Stop (☞ pg. 38)
5 REW Button	Retake (rewind)/Quick Review (☞ pg. 19)	Rewind, Reverse Shuttle Search (☞ pg. 38, 40)
6 INSERT Button	—	Insert Editing (☞ pg. 46)
7 START/STOP Button	Functions the same as the Recording Start/Stop Button on the camcorder.	
8 INT. TIME Button	Self-Timer/Time-Lapse (☞ pg. 45)	—
9 REC TIME Button	Animation/Time-Lapse (☞ pg. 45)	—
10 PAUSE Button	—	Pause (☞ pg. 40)
11 FF Button	Retake (forward) (☞ pg. 19)	Fast-Forward, Forward Shuttle Search (☞ pg. 38, 40)
12 A.DUB Button	—	Audio dubbing (☞ pg. 47)

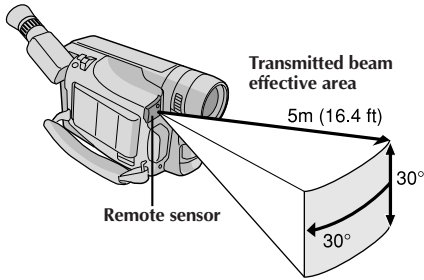

When using the remote control, be sure to point it at the remote sensor. The above illustration shows the approximate transmitted beam effective area for indoor use.

The transmitted beam may not be effective or may cause incorrect operation outdoors or when the remote sensor is directly exposed to sunlight or powerful lighting.

Interval timer indicator

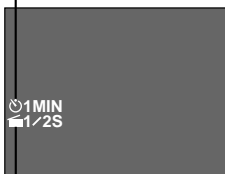

Rec time indicator

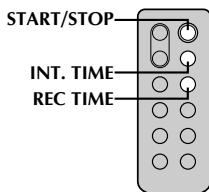
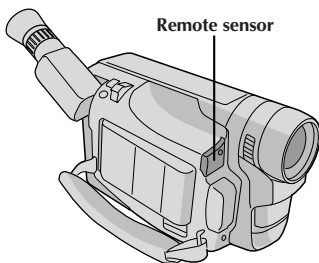

RM-V705U
(provided with GR-AX957/AX857,
optional for GR-AX657)

FEATURE: Self-Timer, Animation and Time-Lapse

PURPOSE:

The remote control lets you set/release Interval Timer and Rec Time functions without using the Menu Screen.

OPERATION:

Self-Timer

1) Set

Instead of performing steps **1** through **4** on pg. 36 ("Self-Timer"), press **INT. TIME** on the remote control. Each time **INT. TIME** is pressed, the Interval Timer indicator appears, changing in the following order: 15S, 30S, 1MIN, 5MIN and No indication (off).

2) Release

Instead of setting "INT. TIME" to "OFF" in the Menu, press **INT. TIME** on the remote control until the Interval Timer indicator disappears.

Animation

1) Set

Instead of performing steps **1** and **2** on pg. 37 ("Animation"), press **REC TIME** on the remote control. Each time **REC TIME** is pressed, the Rec Time indicator appears, changing in the following order: 1/4S, 1/2S, 1S, 5S and No indication (off).

2) Release

Instead of using the Menu in step **5** on pg. 37, press **REC TIME** on the remote control until the Rec Time indicator disappears.

Time-Lapse

1) Set

Instead of performing steps **1** through **3** on pg. 37 ("Time-Lapse"), press **INT. TIME** and **REC TIME** on the remote control. Each time **INT. TIME** is pressed, the Interval Timer indicator appears, changing in the following order: 15S, 30S, 1MIN, 5MIN and No indication (off). Each time **REC TIME** is pressed, the Rec Time indicator appears, changing in the following order: 1/4S, 1/2S, 1S, 5S and No indication (off).

2) Release

Instead of using the Menu in step **5** on pg. 37, press **INT. TIME** and **REC TIME** on the remote control until the indicators disappear.

NOTE:

Also refer to pgs. 36 and 37.

Power Switch

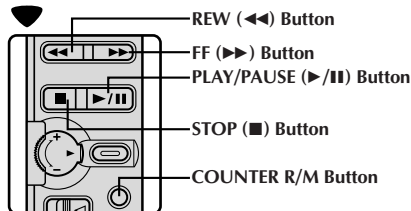
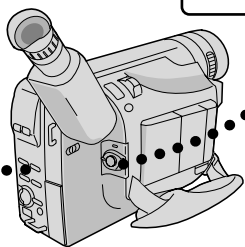
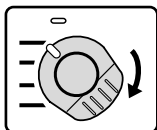

Display

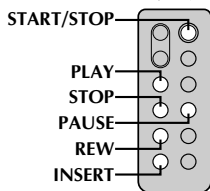
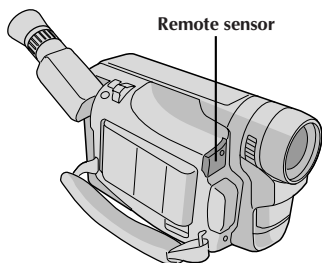
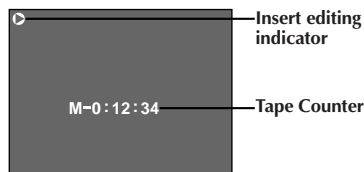

RM-V705U

(provided with GR-AX957/AX857,
optional for GR-AX657)

Insert Editing

You can record a new scene onto a previously recorded tape, replacing a section of the original recording with minimal picture distortion at the in- and out-points. The original audio remains unchanged.

NOTE:

Use the RM-V705U remote control unit to perform this procedure.

- 1 SELECT OPERATION MODE**
Set the Power Switch to "PLAY".
- 2 FIND EDIT-OUT POINT**
Play back the tape, locate the point and press **PAUSE** on the camcorder or the remote control.
- 3 RESET COUNTER**
Press and hold **COUNTER R/M** for more than 1 second to reset the tape counter, then press again for less than 1 second so that "M" appears.
- 4 FIND EDIT-IN POINT**
Press **REW** to go a little beyond the beginning of the scene you want to replace, press **PLAY** to view the recorded tape, and press **PAUSE** exactly at the point where the new scene should start.
- 5 ENGAGE INSERT EDITING MODE**
Press and hold **INSERT**, and without releasing **INSERT**, press and release **PAUSE**. The Insert Editing standby mode is engaged. The Insert Editing Indicator is displayed on the top left corner of the viewfinder. When the scene the camcorder is aimed at appears on the screen, go to the next step.
- 6 BEGIN INSERT EDITING**
Press **START/STOP**. When the counter reaches "0:00:00", editing stops automatically and the camcorder enters the Insert-Pause mode.
- 7 END INSERT EDITING**
Press **STOP**.

NOTES:

- After step 5, Retake (⏮ pg. 19) can be performed.
- The tape may stop slightly before or after the designated end point, and noise bars may appear. Neither indicates a defect in the unit.
- Only the video signal is recorded in the Insert Editing mode.

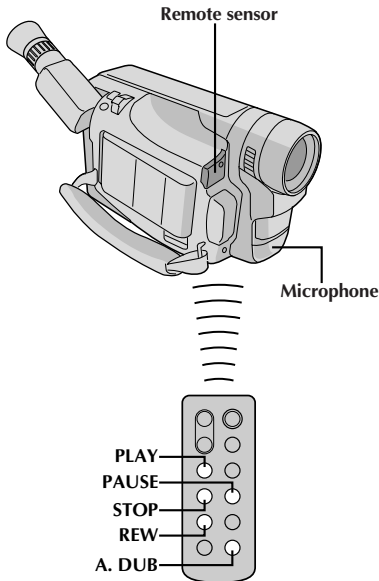
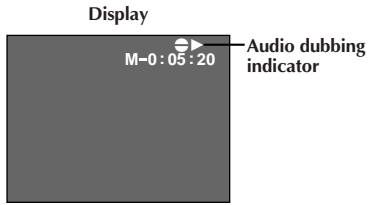

RM-V705U
(provided with GR-AX957/AX857,
optional for GR-AX657)

Audio Dubbing

You can record a new soundtrack on a prerecorded tape (normal audio only).

Perform steps **1**, **2** and **3** of the Insert Editing procedure (pg. 46) before continuing.

- The sound comes from the built-in microphone.

1 FIND EDIT-IN POINT

Press **REW** to go a little beyond the beginning of the scene onto which you want to dub the new audio, press **PLAY** to view the recorded tape, then press **PAUSE** at exactly the point where dubbing should start.

2 ENGAGE AUDIO DUB-STANDBY MODE

Press and hold **A. DUB**, and without releasing **A. DUB**, press and release **PAUSE**. The Audio Dub standby mode is engaged. The Audio Dubbing Indicator is displayed on the top right corner of the viewfinder.

3 BEGIN AUDIO DUBBING

Press **PLAY**. When the counter reaches "0:00:00", Audio Dubbing stops automatically and the camcorder enters the Audio Dub-Standby mode.

4 END AUDIO DUBBING

Press **STOP**.

NOTES:

- Do not press **FF** or **REW** during Audio Dub-Standby, or the edit points will not be accurate.
- If the microphone is too close to the TV, or if the TV's volume is too high, whistling or howling may occur.

NOTES (for Insert Editing and Audio Dubbing):

- Insert Editing and Audio Dubbing may not work correctly if the tape contains blank segments, or if the recording speed was changed during the original recording.
- To edit/dub onto a tape, make sure the Erase Protection tab is in the position that allows recording. If not, slide the tab. Some cassettes have removable tabs. If the tab has been removed, cover the hole with adhesive tape.
- Do not press **STOP** during Insert Editing or Audio Dubbing, or the edit points will not be accurate.
- During Insert Editing and Audio Dubbing, when Insert-Pause or Audio Dub-Standby is engaged, the counter may go slightly past "0:00:00". Recording, however, stops at exactly 0:00:00.

LENS COVER Open/Close Ring

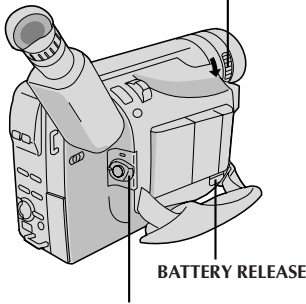

Set to "POWER OFF".

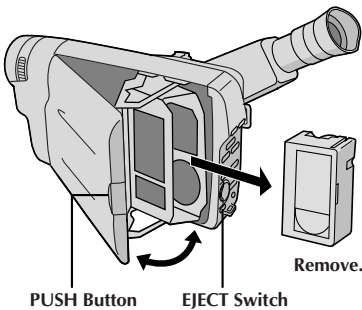

PUSH Button

EJECT Switch

Remove.

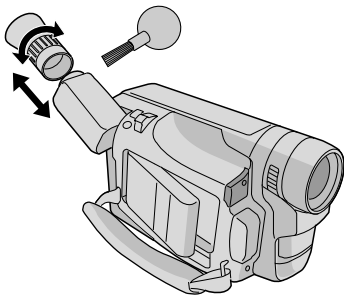

After Use

- 1** Set the Power Switch to "POWER OFF" to turn off the camcorder.
- 2** Close and lock the cassette holder by pressing **PUSH**.
- 3** Slide **BATTERY RELEASE** to remove the battery pack.
- 4** Turn the **LENS COVER Open/Close Ring** to close the lens cover.

Cleaning The Camcorder

- 1 CLEAN EXTERIOR**
Wipe gently with a soft cloth.
 - Put cloth in diluted mild soap and wring it well to wipe off heavy dirt, then wipe again with a dry cloth.
- 2 CLEAN LENS**
Blow it with a blower brush, then wipe it gently with lens cleaning paper.
- 3 REMOVE EYEPIECE**
Turn the eyepiece counterclockwise and pull it out.
- 4 CLEAN VIEWFINDER**
Remove dust using a blower brush.
- 5 RE-ATTACH EYEPIECE**
Re-attach the eyepiece and turn it clockwise.

NOTES:

- Avoid using strong cleaning agents such as benzine or alcohol.
- Cleaning should be done only after the battery pack has been removed or other power units have been disconnected.
- Mold may form if the lens is left dirty.
- When using a cleaner or chemically treated cloth, refer to the cautions that came with it.
- When removing the eyepiece, be sure to hold the viewfinder securely.

If, after following the steps in the chart below, the problem still exists, please consult your JVC dealer.

The camcorder is a microcomputer-controlled device. External noise and interference (from a TV, a radio, etc.) might prevent it from functioning properly. In such cases, first disconnect its power supply unit (battery pack, AC Power Adapter/Battery Charger, etc.) and clock battery; and then re-connect it and proceed as usual from the beginning.

SYMPTOM	POSSIBLE CAUSE(S)
POWER	
No power is supplied.	<ul style="list-style-type: none"> ● The battery pack has not been attached correctly (☞ pg. 8). ● The battery pack is not charged (☞ pg. 8). ● The power supply has not been correctly connected (☞ pg. 9).
The power suddenly goes off and does not come back on by itself.	<ul style="list-style-type: none"> ● The battery pack has completely discharged. ● Remove the cassette and disconnect the power source, then after a few minutes, try turning the power back on. If it still does not come on, consult your nearest JVC dealer.
RECORDING	
Recording cannot be performed.	<ul style="list-style-type: none"> ● Make sure the Erase Protection tab is in the position that allows recording. If not, slide the tab. Some cassettes have removable tabs. If the tab has been removed, cover the hole with adhesive tape.
Recording does not start.	<ul style="list-style-type: none"> ● The camcorder Power Switch has not been set to "CAMERA" ("AUTO" or "PRO.") (☞ pg. 16).
Animation or Time-Lapse is not available.	<ul style="list-style-type: none"> ● Before recording in the Animation mode at the very beginning of a tape, set the camcorder to the Recording mode for about 5 seconds, so that the tape runs smoothly. Using the Fade-in function at this point is a good way to begin an animated program (☞ pg. 37, 45).
PLAYBACK	
The tape is running, but there is no playback picture.	<ul style="list-style-type: none"> ● The TV has not been set to its VIDEO mode or channel. ● If A/V connection is used, the TV's VIDEO/TV Switch has not been set to VIDEO.
Playback picture is blurred or interrupted.	<ul style="list-style-type: none"> ● The video heads are dirty or worn out. Consult your nearest JVC dealer for head cleaning or replacement.
The counter indication is blurred during Still playback.	<ul style="list-style-type: none"> ● This is normal.
TAPE TRANSPORT	
The tape stops during fast-forward or rewind.	<ul style="list-style-type: none"> ● The Counter Memory Function has been activated (☞ pg. 40).
Rewinding or fast-forwarding cannot be performed.	<ul style="list-style-type: none"> ● The tape is already fully wound on one reel or the other.



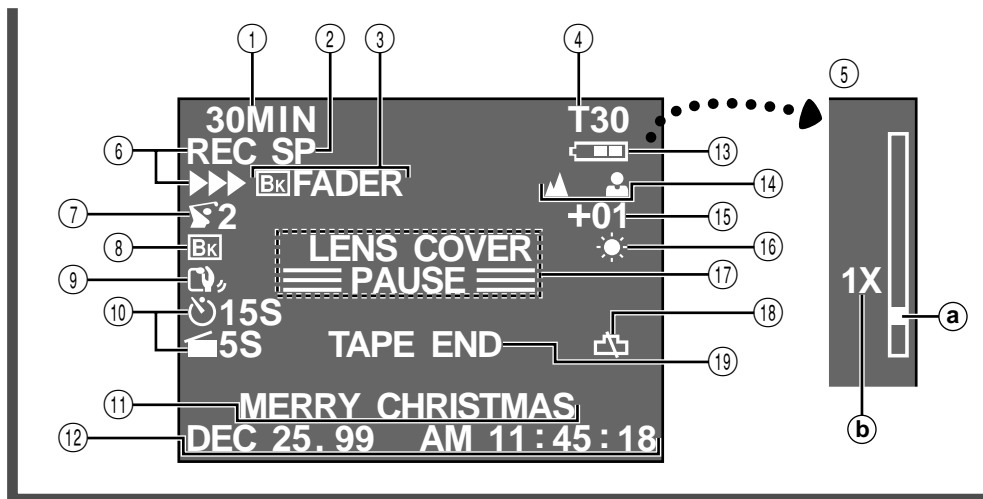



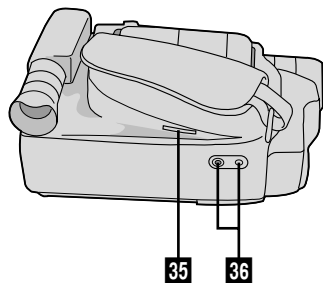
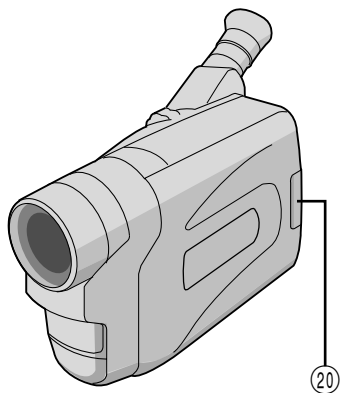
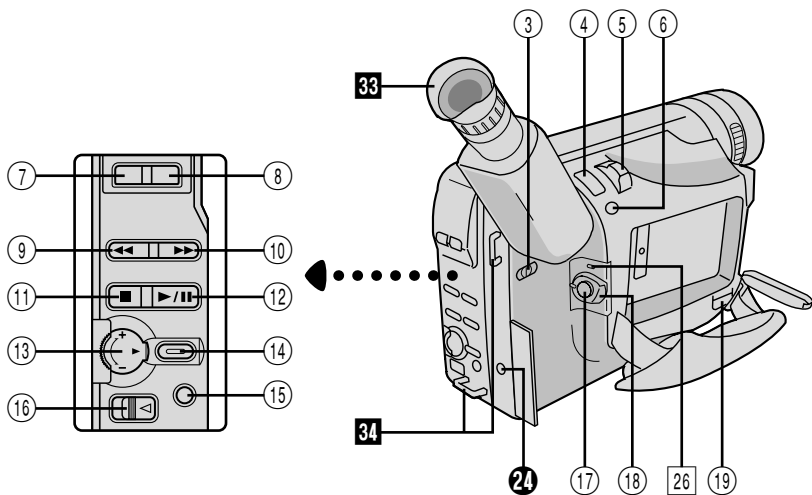
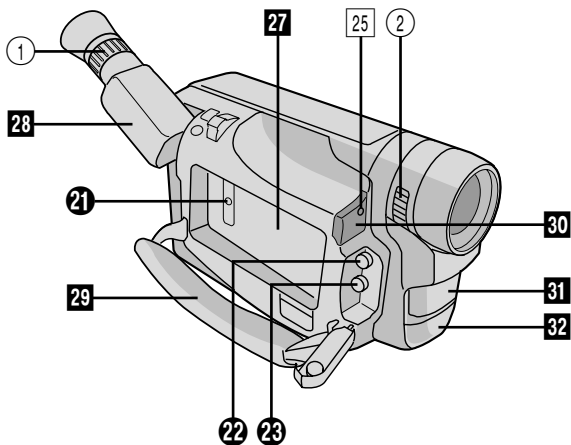

















SYMPTOM	POSSIBLE CAUSE(S)
OTHER	
During recording, the indications do not appear.	<ul style="list-style-type: none"> ● Press DISPLAY for longer than 1 second to make the indications appear (☞ pg. 17).
The tape will not eject.	<ul style="list-style-type: none"> ● The battery pack is running low.
Some functions are not available.	<ul style="list-style-type: none"> ● The Power Switch is set to "AUTO". ● Certain combinations of modes or effects are not possible to use.
Vertical white lines appear when shooting a very bright object.	<ul style="list-style-type: none"> ● This sometimes occurs when the contrast between the background and the object is great. It is not a defect of the camcorder.
Bright, crystal-shaped spots appear in the viewfinder.	<ul style="list-style-type: none"> ● Sunlight is directly entering the lens. This is not a defect of the camcorder.
Colored bright spots appear all over the viewfinder.	<ul style="list-style-type: none"> ● The viewfinder is made with high-precision technology. However, black spots or bright spots of light (red, green or blue) may appear constantly in the viewfinder. These spots are not recorded on the tape. This is not due to any defect of the unit. (Effective dots: more than 99.99 %.)
The viewfinder and the lens have become dirty (ex. fingerprints).	<ul style="list-style-type: none"> ● Wipe them gently with a soft cloth. Gently wipe in a semicircular motion, as wiping strongly spreads the stain and it won't come out easily.
The picture is blurred in the Quick Review or Retake mode.	<ul style="list-style-type: none"> ● This is normal while recording in the EP mode. Some noise may be present while recording in the SP mode (☞ pg. 12).
An error number (i.e. E03) appears.	<ul style="list-style-type: none"> ● Turn the camcorder's power off, then disconnect the power source. After a few minutes, try turning the power on again. If the error number still appears in the viewfinder, consult your nearest JVC dealer.
The image is out of focus.	<ul style="list-style-type: none"> ● The diopter needs to be adjusted (☞ pg. 14). ● The scene being shot is adversely affecting the operation of Auto Focus (☞ pg. 32).
The date and time displays disappear.	<ul style="list-style-type: none"> ● If you remove the power source from the camcorder while the power is on, all settings and selections are erased. Make sure to turn the camcorder's power off before disconnecting the power source.
The wrong date and time are displayed/recorded.	<ul style="list-style-type: none"> ● If you have not performed Date/Time Setting (☞ pg. 11), the date and time are not displayed/recorded correctly. Be sure that Date/Time setting is carried out.
Even though the lens cover is open, the Lens Cover Warning indicator blinks.	<ul style="list-style-type: none"> ● The Lens Cover Warning indicator may blink when the camcorder is used in dark areas, regardless of the position of the lens cover.



- ① **Cassette Warning/**
Tape Remaining Time pg. 17
When no cassette is inserted: the cassette () warning blinks.
When the Erase Protection tab is not in the position that allows recording: the cassette () warning lights. Otherwise, the tape remaining time is displayed and the tape remaining time warning blinks when the tape is about to reach its end.
When the Power Switch is set to "PLAY" and a tape is loaded: the cassette () mark is displayed regardless of the Erase Protection tab's position.
- ② **Recording Mode (SP/EP) Indicator** pg. 12
- ③, ⑦ **Program AE Indicator** pg. 24
Displayed at ③ for approx. 2 seconds when Program AE with special effects is switched from one mode to another by pressing **P.AE.**, then only the indicator remains at ⑦.
- ③, ⑧ **Fade/Wipe-Standby Indicator** pg. 23
Displayed at ③ for approx. 2 seconds when the Fade/Wipe is switched from one effect to another by pressing **EFFECT**, then only the indicator remains at ⑧.
- ④ **Tape Length Indicator** pg. 12
- ⑤ **Zoom Indicator Bar** pg. 18
 - Ⓐ **Zoom Level Indicator**
 - Ⓑ **Approximate Zoom Ratio**
- ⑥ **Recording Indicator** pg. 16
- ⑨ **Picture Stabilizer Indicator** pg. 20
- ⑩ **Interval Timer/Recording Time Indicator** pg. 36
 - 5 Sec. Rec Mode Indicator pg. 19 (GR-AX857/AX657 only)
- ⑪ **Instant Title Display** pg. 27
- ⑫ **Date/Time Display** pg. 26
- ⑬ **Battery Pack Remaining Power Indicator**
Changes as follows according to the battery pack's remaining power level:
"→→→". When the power is almost gone, the indicator "" blinks (battery power warning), then the unit shuts off. Replace the battery pack with a fully charged one.
Note: The symbol containing 3 darkened squares — — does not necessarily mean that the battery pack is fully charged.
- ⑭ **Focus Indicator** pg. 33
- ⑮ **Exposure Control Level Counter** pg. 31
- ⑯ **White Balance Mode Indicator** pg. 34
- ⑰ **Record-Standby Mode Indicator** pg. 16
 - **Lens Cover Warning:**
LENS COVER pg. 17
- ⑱ **Clock Battery Warning**
Blinks for approx. 10 seconds when the power is turned on. This display also blinks when the clock (lithium) battery is either not installed or has discharged. Install or replace the old battery with a new one (pg. 10).
 - **Tape End Display: TAPE END** pg. 17
Appears when the end of the tape is reached during playback, recording or fast-forward.
 - **Condensation Warning:**
When this indication appears, all functions except tape eject and power on/off are disabled. Turn the unit off (without removing the power source) for a few hours, and when you turn it on again the indication should disappear.
 - **Head Clog Warning:**
Appears if dirty heads are detected during recording. In such a case, use the optional Cleaning Cassette. If, after using it, the problems still exist, consult your nearest JVC dealer.





Controls

- ① Diopter Adjustment Control  pg. 14
- ② Lens Cover Open/Close Ring  pg. 16
- ③ Video Light Switch [LIGHT OFF/AUTO/ON]
(GR-AX957/AX857 only)  pg. 21
- ④ • Snapshot Button [SNAPSHOT]
(GR-AX957 only)  pg. 22
- 5-Second Recording Button [5 SEC. REC]
(GR-AX857/657 only)  pg. 19
- ⑤ Power Zoom Lever [T/W]  pg. 18
- ⑥ Picture Stabilizer Button
[P.STABILIZER]  pg. 20
- ⑦ Program AE Button [P.AE]  pg. 24
- ⑧ Fade/Wipe Button [EFFECT]  pg. 23
- ⑨ • Rewind Button [◀◀, REW]  pg. 38
- Retake Rewind Button [RETAKE R]  pg. 19
- Quick Review Button [Ⓜ R]  pg. 19
- ⑩ • Fast-Forward Button [▶▶, FF]  pg. 38
- Retake Forward Button [RETAKE F]  pg. 19
- ⑪ Stop Button [■, STOP]  pg. 38
- ⑫ Play/Pause Button
[▶/⏸, PLAY/PAUSE]  pg. 38
- ⑬ Select Dial [+ , - , PUSH]  pg. 11, 28
- ⑭ MENU/DISPLAY Button  pg. 17, 28
- ⑮ • Counter Reset/Memory Button
[COUNTER R/M]  pg. 40
- Recording Mode Button [SP/EP]  pg. 12
- ⑯ EJECT Switch  pg. 13
- ⑰ Recording Start/Stop Button  pg. 16
- ⑱ Power Switch  pg. 16, 38
- ⑲ Battery Release Switch
[BATTERY RELEASE]  pg. 8
- ⑳ PUSH Button  pg. 13



Connectors

- ㉑ DC IN Jack  pg. 9









The connectors ㉒ to ㉔ are located beneath the cover.

- ㉒ Video Output Connector  pg. 42
- ㉓ Audio Output Connector  pg. 42
- ㉔ J Terminal [JLIP (Joint Level Interface Protocol) Connector]
- It is used to connect the camcorder to a device such as a personal computer.
For further details consult your nearest JVC dealer.
 - JLIP-controlled editing from camcorder to VCR is not possible if the VCR is not equipped with a J terminal.





Indicators

- ㉕ Tally Lamp  pg. 16
- ㉖ Power Lamp  pg. 16



Other Parts

- ㉗ Battery Pack Mount  pg. 8
- ㉘ Viewfinder  pg. 14
- ㉙ Grip Strap  pg. 14
- ㉚ • Camera Sensor
Be careful not to cover this area; a sensor necessary for shooting is built-in here.
- Remote Sensor  pg. 44
- ㉛ Video Light
(GR-AX957/AX857 only)  pg. 21
- ㉜ Microphone
For use when recording.
- ㉝ Eyepiece  pg. 48
- ㉞ Shoulder Strap Eyelets  pg. 15
- ㉟ Clock Battery Slot  pg. 10
- ㊱ Tripod Mounting Socket  pg. 15



A

- AC Power Adapter/Charger  pg. 8, 9
- Animation Recording  pg. 37
- Auto Date Record  pg. 26
- Auto Focus  pg. 32
- Auto Shut off  pg. 17, 38









B

- Battery Pack  pg. 8, 9, 55
- Brighten The Image  pg. 31

C

- Car Battery  pg. 9
- Charge Marker  pg. 9
- Charge The Battery Pack  pg. 8
- Clean The Camcorder  pg. 48
- Clock (Lithium) Battery  pg. 10
- Connections  pg. 9, 42

D

- Darken The Image  pg. 31
- Date/Time Display  pg. 26
- Date/Time Settings  pg. 11
- Demonstration Mode  pg. 30
- Digital Zoom  pg. 29
- Discharge The Battery Pack  pg. 8
- Diopter Adjustment  pg. 14
- Dubbing  pg. 43

E

- Electronic Fog Filter Mode  pg. 25
- Erase Protection  pg. 13
- Exposure Control  pg. 31

F

- Fade-In/Out  pg. 23
- Fast-Forward Tape  pg. 38
- 5 Sec. Recording  pg. 19

G

- Grip Adjustment  pg. 14

H

- High Speed Shutter Mode  pg. 25

I

- Instant Titles  pg. 27



L

- Load A Tape  pg. 13

M

- Manual Focus  pg. 33
- Menu Screen  pg. 29, 30

N

- ND Effect Mode  pg. 25
- Nega/Posi Mode  pg. 25





P

- Picture Stabilizer  pg. 20
- Power Switch Position  pg. 16
- Program AE With Special Effects  pg. 24
- Provided Accessories  pg. 6









Q

- Quick Review  pg. 19









R

- Record-Standby  pg. 16
- Recording Mode  pg. 12
- Retake  pg. 19
- Rewind The Tape  pg. 38

S

- Self-Timer  pg. 36
- Sepia  pg. 25
- Shoulder Strap Attachment  pg. 15
- Shuttle Search  pg. 40
- Snapshot Mode  pg. 22
- Specifications  pg. 57
- Still Playback  pg. 40
- Super LoLux (S.LX)  pg. 29

T

- Tally  pg. 30
- Tape Counter  pg. 38
- Tape Length Setting  pg. 12
- Tele Macro  pg. 29
- Time-Lapse Shooting  pg. 37
- Tracking  pg. 39
- Tripod Mounting  pg. 15
- Twilight  pg. 25



U

- Unload A Tape  pg. 13

V

- Video Light  pg. 21
- Viewfinder Adjustment  pg. 14
- Viewfinder Indications  pg. 51

W

- White Balance  pg. 34, 35
- Wide Mode  pg. 29
- Wipe In/Out  pg. 23

Z

- Zooming  pg. 18

DANGER:

Video Light

- The video light becomes extremely hot. Do not touch it either while in operation or soon after turning it off, otherwise serious injury may result.
- Do not place the camcorder into the carrying case immediately after using the video light, since it remains extremely hot for some time.
- When operating, keep a distance of about 30 cm (1 ft.) between the video light and people or object.
- Do not use near flammable or explosive materials.
- It is recommended that you consult your nearest JVC dealer for replacing the video light.

When using the AC Power Adapter/Charger in areas other than the USA

- The provided AC Power Adapter/Charger features automatic voltage selection in the AC range from 110 V to 240 V.

USING HOUSEHOLD AC PLUG ADAPTER

In case of connecting the unit's power cord to an AC wall outlet other than American National Standard C73 series type use an AC plug adapter, called a "Siemens Plug", as shown.

For this AC plug adapter, consult your nearest JVC dealer.

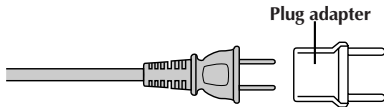

General Battery Precautions

- When the C-P6U or C-P7U (cassette adapter) is not functioning even when correctly operated, the battery is exhausted. Replace it with a fresh one.
- Use only the following battery:
C-P6U or C-P7U AA (R6) size

Please make note of the following rules for battery use. When misused, the battery can leak or explode.

1. Refer to the C-P6U/C-P7U instructions when replacing the battery.
2. **Do not** expose the battery to excessive heat as it can leak or explode.
3. **Do not** dispose of the battery in a fire.
4. Remove the battery from the unit if it is to be stored for an extended period to avoid battery leakage which can cause malfunctions.

Battery Packs

The battery packs are nickel-cadmium or nickel metal-hydride batteries.

Before using the supplied battery pack or an optional battery pack, be sure to read the following cautions:

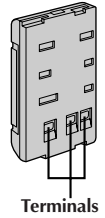

1. **To avoid hazard . . .**
 - ... do not burn.
 - ... do not short-circuit the terminals.
 - ... do not modify or disassemble.
 - ... use only specified chargers.
2. **To prevent damage and prolong service life . . .**
 - ... do not subject to unnecessary shock.
 - ... avoid repeated charging without fully discharging.
 - ... charge in an environment where temperatures are within the tolerances shown in the chart below. This is a chemical reaction type battery—cooler temperatures impede chemical reaction, while warmer temperatures can prevent complete charging.
 - ... store in a cool, dry place. Extended exposure to high temperatures will increase natural discharge and shorten service life.
 - ... avoid prolonged uncharged storage.
 - ... remove from charger or powered unit when not in use, as some machines use current even when switched off.

NOTES:

- It is normal for the battery pack to be warm after charging, or after use.
Temperature Range Specifications
Charging 10°C to 35°C (50°F to 95°F)
Operation 0°C to 40°C (32°F to 104°F)
Storage -10°C to 30°C (14°F to 86°F)
- Recharging time is based on room temperature of 20°C (68°F).
- The lower the temperature, the longer recharging takes.

Cassettes

To properly use and store your cassettes, be sure to read the following cautions:

1. During use . . .

- ... make sure the cassette bears the VHS-C mark.
- ... be aware that recording onto prerecorded tapes automatically erases the previously recorded video and audio signals.
- ... make sure the cassette is positioned properly when inserting.
- ... do not load and unload the cassette repeatedly without allowing the tape to run at all. This slackens the tape and can result in damage.
- ... do not open the front tape cover. This exposes the tape to fingerprints and dust.

2. Store cassettes . . .

- ... away from heaters or other heat sources.
- ... out of direct sunlight.
- ... where they won't be subject to unnecessary shock or vibration.
- ... where they won't be exposed to strong magnetic fields (such as those generated by motors, transformers or magnets).
- ... vertically, in their original cases.

Main Unit

1. For safety, DO NOT . . .

- ... open the camcorder's chassis.
- ... disassemble or modify the unit.
- ... short-circuit the terminals of the battery pack. Keep it away from metallic objects when not in use.
- ... allow inflammables, water or metallic objects to enter the unit.
- ... remove the battery pack or disconnect the power supply while the power is on.
- ... leave the battery pack attached when the camcorder is not in use.

2. Avoid using the unit . . .

- ... in places subject to excessive humidity or dust.
- ... in places subject to soot or steam such as near a cooking stove.
- ... in places subject to excessive shock or vibration.
- ... near a television set.
- ... near appliances generating strong magnetic or electric fields (speakers, broadcasting antennas, etc.).
- ... in places subject to extremely high (over 40°C or 104°F) or extremely low (under 0°C or 32°F) temperatures.

3. DO NOT leave the unit . . .

- ... in places of over 50°C (122°F).
- ... in places where humidity is extremely low. (below 35%) or extremely high (above 80%).
- ... in direct sunlight.
- ... in a closed car in summer.
- ... near a heater.

4. To protect the unit, DO NOT . . .

- ... allow it to become wet.
- ... drop the unit or strike it against hard objects.
- ... subject it to shock or excessive vibration during transportation.
- ... keep the lens directed at extremely bright objects for long periods.
- ... direct the eyepiece of the viewfinder at the sun.
- ... carry it by holding the viewfinder. Be sure to hold the main unit with both hands or use the grip.
- ... swing it excessively when using the shoulder strap.

About moisture condensation . . .



- You may have observed that pouring a cold liquid into a glass will cause drops of water to form on the glass' outer surface. This same phenomenon occurs on the head drum of a camcorder when it is moved from a cool place to a warm place, after heating a cold room, under extremely humid conditions or in a place directly subjected to the cool air from an air conditioner.
- Moisture on the head drum can cause severe damage to the video tape, and can lead to internal damage to the camcorder itself.

Serious malfunctioning

If malfunctioning occurs, stop using the unit immediately and consult your local JVC dealer.

Camcorder



General

Format	: VHS NTSC standard	Operating temperature	: 0°C to 40°C (32°F to 104°F)
Power source	: DC 6.0 V 	Operating humidity	: 35% to 80%
Power consumption		Storage temperature	: -20°C to 50°C (-4°F to 122°F)
GR-AX957/AX857		Weight	
light on	: 8.3 W	GR-AX957/AX857	: Approx. 880 g (2.0 lbs)
light off	: 5.4 W	GR-AX657	: Approx. 940 g (2.1 lbs)
GR-AX657	: 5.4 W	Dimensions	: 91 (W) x 119 (H) x 198 (D) mm (3-15/16" x 4-11/16" x 7-13/16") (with the viewfinder fully tilted downward)
Video light	: 2.9 W	Pickup	: 1/4" format CCD
Signal system	: NTSC-type	Lens	: F1.6, f = 3.9 to 62.4 mm, 16:1 power zoom lens with auto iris and macro control, filter diameter 40.5 mm
Video recording system		Viewfinder	: Electronic viewfinder with
Luminance	: FM recording	GR-AX957/AX857	: • 0.55" color LCD
Color	: Converted sub-carrier direct recording Conforms to VHS standard	GR-AX657	: • 0.5" black/white CRT
Cassette	:  cassette	White balance adjustment	: Auto/Manual adjustment
Tape speed			
SP	: 33.35 mm/sec. (1-5/16 ips)		
EP	: 11.12 mm/sec. (7/16 ips)		
Recording time (max.)			
SP	: 40 minutes		
EP	: 120 minutes (with TC-40)		

Connectors

JLIP:	ø3.5 mm, 4-pole, mini-head jack (compatible with RC-5325 plug)	Video	: 1 Vp-p, 75 Ω unbalanced, analog output (via Video output connector)
		Audio	: -8 dBs, 1 kΩ analog output (via Audio output connector)

AC Power Adapter/Charger AA-V15U

Power requirement	
U.S.A. and Canada	: AC 120 V~, 60 Hz
Other countries	: AC 110 V to 240 V~, 50/60 Hz
Power consumption	: 23 W
Output	
Charge	: DC 8.5 V  , 1.3 A
VTR	: DC 6.3 V  , 1.8 A
Charging system	: Constant current, peak detection, timer controlled
Dimensions	: 140 (W) x 42 (H) x 68 (D) mm (5-9/16" x 1-11/16" x 2-11/16")
Weight	: Approx. 300 g (0.71 lbs)

Cassette Adapter C-P7U

Dimensions	: 188 (W) x 25 (H) x 104 (D) mm (7-7/16" x 1" x 4-1/8")
Weight	: Approx. 240 g (0.53 lbs)
Accessory	: "AA (R6)"-size battery x 1

Provided Accessories pg. 6

Optional Accessories

- Battery Packs BN-V12U, BN-V20U, BN-V856U
- Car Battery Charger BH-V3U
- Battery Charger BH-VC10U
- Car Battery Cord AP-V7U
- Compact VHS-C Cassettes TC-40/30/20
- Active Carrying Bag CB-V7U
- Audio/Video Cable

Some accessories are not available in some areas. Please consult your nearest JVC dealer for details on accessories and their availability.

Specifications shown are for SP mode unless otherwise indicated. E & O.E. Design and specifications subject to change without notice.

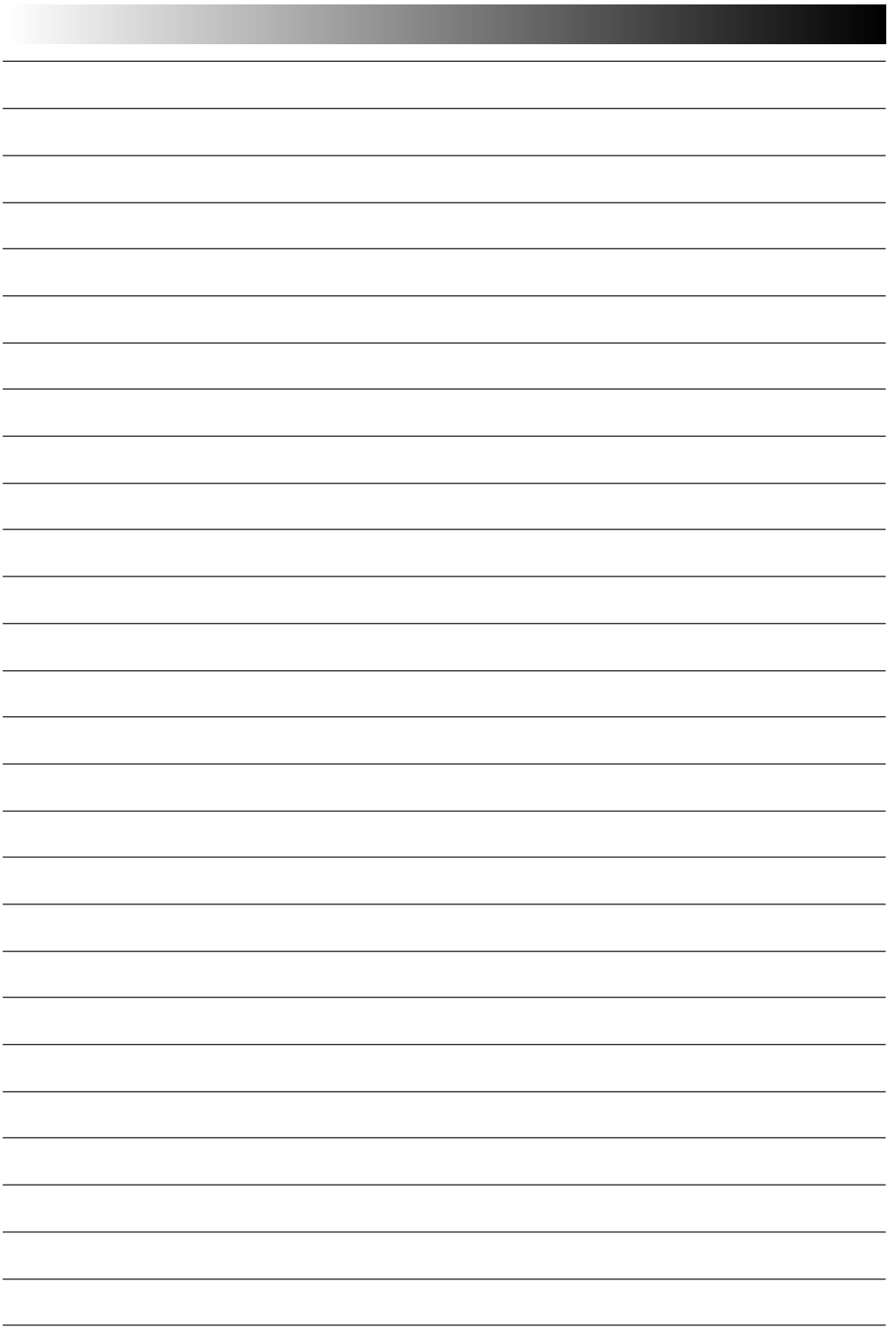



A series of 22 horizontal lines providing a template for handwriting practice, spaced evenly across the page.

EN

GR-AX957UM
GR-AX857UM
GR-AX657UM

JVC

VICTOR COMPANY OF JAPAN, LIMITED